



SHAMS
AL ANDALUS[®]
SMART ENERGY SOLUTIONS

LED FLOOD LIGHT

—LIGHT THE WORLD—



Certification: CE,ROHS,TUV,FCC,DLC/ETL,SAA,C-tick

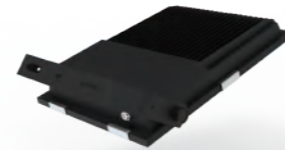

ITEM No.	MFL-S10	MFL-S20	MFL-S30	MFL-S50
Led Power	10W	20W	30W	50W
Lumen Output	1300lm	2600lm	3900lm	6500lm
Weight	0.4kg	0.7kg	1.3kg	2.56kg
Product size(mm)	L130*W166*H32	L174*W216*H40	L198*W226*H40	L260*W311*H50
Carton size(mm)	425*415*255, 36pcs/CTN	515*380*260, 20pcs/CTN	535*405*260, 20pcs/CTN	530*365*255, 8pcs/CTN

ITEM No.	MFL-S80	MFL-S100	MFL-S150	MFL-S200
Led Power	80W	100W	150W	200W
Lumen Output	10400lm	13000lm	19500lm	26000lm
Weight	4.77kg	6.07kg	7.8kg	8kg
Product size(mm)	L290*W355*H55	L330*W403*H61	L371*W431*H60	L401*W471*H60
Carton size(mm)	435*340*130, 1pcs/CTN	510*430*135, 1pcs/CTN	510*430*135, 1pcs/CTN	555*460*135, 1pcs/CTN

LED FLOOD LIGHT

—LIGHT THE WORLD—



Beam angle	8°, 15°, 30°, 35°, 60°, 90°, 120°; 140°*70°, 70°*150°, 150°*80°, 50°*140°	CRI	>80
Input Voltage	AC85-300V & DC12/24V	CCT	2700-6500k
Driver Brand	CE/Meanwell driver	IP Grade	IP65
Led Lamp	PHILIPS & OSRAM SMD 3030	Power Factor	>0.95

Installation Instruction for 85-300V/347V

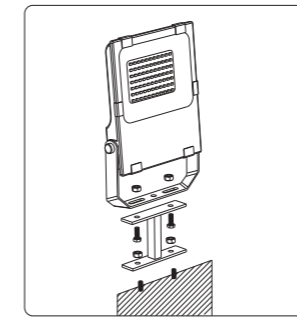

1. Install the lamp by the stand on the ground

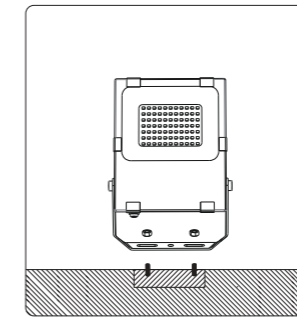

2. Install lamp directly

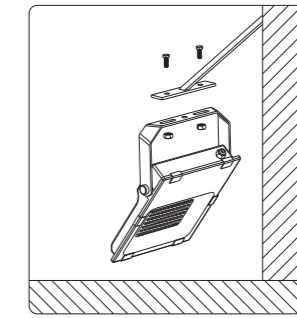

3. Hang the lamp by the stand

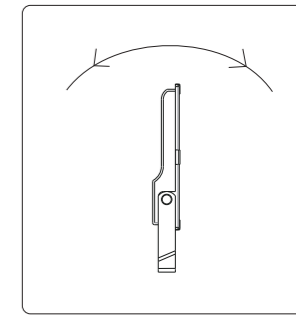

4. The angle of the lamp is adjustable

Beam angle

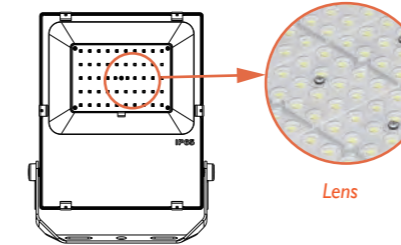

Package Including

1. One pc Slim LED Flood Light
2. One pc Slim LED Flood Light User Manual

Features

1. IP65, IK08/IK10.
2. AC85-300V/347V is available.
3. Patent product, Intellectual property right protection.
4. Lumen Efficiency of Lamp Fixture up to 130lm/w.
5. Installation: Bracket.

Application

Widely used in workshop, warehouse, highway toll station, supermarket, exhibition building, gymnasium...etc...

Production Introduction

Slim LED Flood light use high quality SMD3030 LED CHIP and CE certificated LED Driver(AC85-300V) or Taiwan Meanwell UL Driver(AC85-300V/347V). With unique Die-cast aluminum heat sink and tempered glass, the light is ideal product for car parking area, street area and similar applications.

LED FLOOD LIGHT

LIGHT THE WORLD



Certification: CE,ROHS,TUV,FCC,DLC/ETL,SAA,C-tick



ITEM No.	MFL-S10-M	MFL-S20-M	MFL-S30-M	MFL-S40-M
Led Power	10W	20W	30W	40W
Lumen Output	1300lm	2600lm	3900lm	5200lm
Weight	0.5kg	0.5 kg	0.85kg	0.85kg
Arm mount size(mm) 'U' bracket size(mm)	127*191*52 130*115*41	127*191*52 130*115*41	180*193*62 196*150*47	180*193*62 196*150*47
Arm mount package(mm) 'U' bracket package(mm)	280*250*260, 16pcs/CTN 280*250*230, 16pcs/CTN	280*250*260, 16pcs/CTN 280*250*230, 16pcs/CTN	416*432*310, 16pcs/CTN 340*452*258, 16pcs/CTN	416*432*310, 16pcs/CTN 340*452*258, 16pcs/CTN

ITEM No.	MFL-S50-M	MFL-S70-M	MFL-S100-M
Led Power	50W	70W	100W
Lumen Output	6500lm	9100lm	13000lm
Weight	1.25kg	1.35kg	2.05kg
Arm mount size(mm) 'U' bracket size(mm)	219*220*76 194*223*56	219*220*76 194*223*56	289*304*85 239*294*60
Arm mount package(mm) 'U' bracket package(mm)	455*486*365, 16pcs/CTN 408*520*323, 16pcs/CTN	455*486*365, 16pcs/CTN 408*520*323, 16pcs/CTN	658*535*316, 10pcs/CTN 510*455*341, 10pcs/CTN

LED FLOOD LIGHT

LIGHT THE WORLD



Beam angle	15°, 30°, 120°*60°	CRI	>80
Input Voltage	AC85-265V	CCT	2700-6500k
Driver Brand	CE/Meanwell driver	IP Grade	IP65
Led Lamp	PHILIPS SMD 3030	Power Factor	>0.92

Installation Instruction

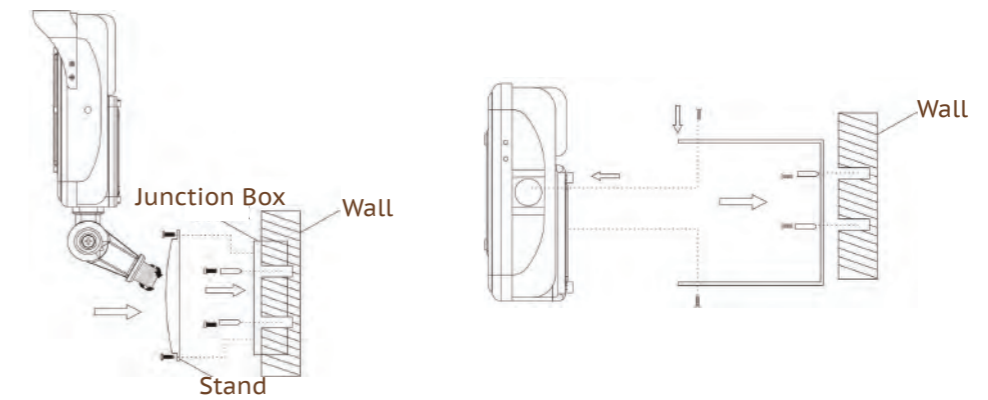

Exploded View

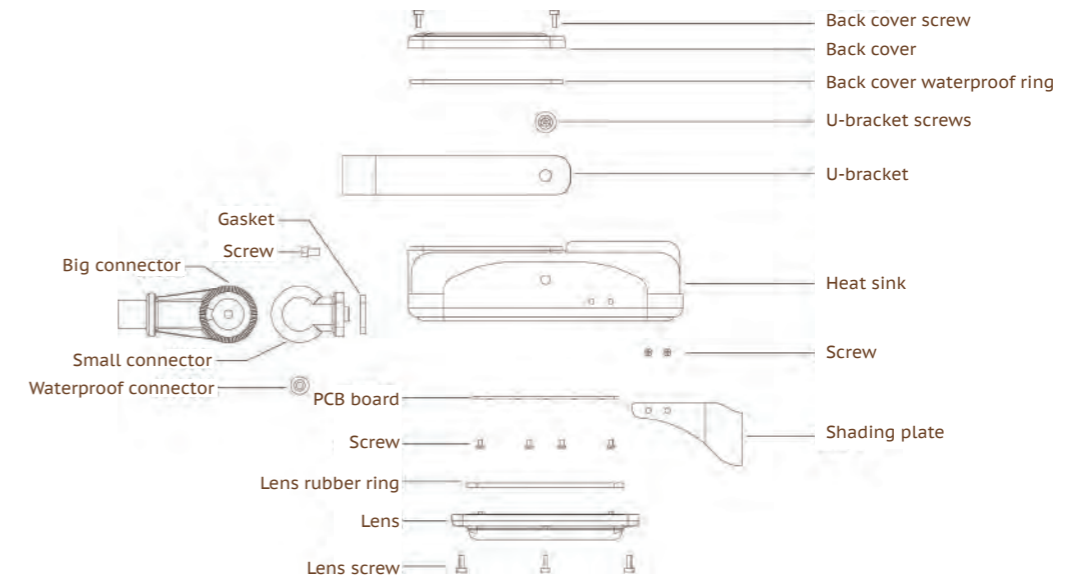

Features

1. Light weight: patented design process and heat dissipation material.
2. Multi-application: The bracket adopts thread lock, high stability, suitable for various complicated and changeable applications.
3. Multi-angle adjustable: Reasonable design facilitates adjustment of different azimuth angles.
4. High protection: The protection level reaches IP65.
5. Professional heat dissipation structure: transparent air duct design inside and outside, which greatly improves the heat dissipation performance and extends the life of the lamp.
6. Large-area die-cast aluminum housing, integrated heat dissipation.

LED FLOOD LIGHT

LIGHT THE WORLD



Certification: CE,ROHS,TUV,FCC,DLC/ETL,SAA,C-tick



ITEM No.	MFL-A100	MFL-A120	MFL-A150	MFL-A200	MFL-A300
Led Power	100W	120W	150W	200W	300W
Lumen Output	11000lm	13200lm	16500lm	22000lm	33000lm
Weight	8.3kg	9.3kg	9.8kg	10.5kg	12.5kg
Product size(mm)	L375*W375*H410	L375*W375*H410	L375*W375*H410	L375*W375*H410	L375*W375*H410
Carton size(mm)	470*470*550, 1 pcs/CTN				

ITEM No.	MFL-A400	MFL-A500	MFL-A800	MFL-A1000	MFL-A1500
Led Power	400W	500W	800W	1000W	1500W
Lumen Output	44000lm	55000lm	88000lm	110000lm	165000lm
Weight	13.5kg	14.5kg	21.5kg	29kg	36kg
Product size(mm)	L375*W375*H448	L375*W385*H449	L445*W482*H507	L445*W558*H507	L445*W653*H507
Carton size(mm)	500*500*600, 1 pcs/CTN	500*500*600, 1 pcs/CTN	530*550*570, 1 pcs/CTN	630*550*570, 1 pcs/CTN	720*550*570, 1 pcs/CTN

LED FLOOD LIGHT

LIGHT THE WORLD



Beam angle	25/45/60/90°	CRI	>80
Input Voltage	AC85-300V & AC180-528V	CCT	2700-6500k
Driver Brand	Meanwell driver	IP Grade	IP65
Led Lamp	PHILIPS SMD 3030	Power Factor	>0.95

Bracket Angle 216°

Mounting Bracket is with 13 adjustable point, 216° adjustable, installation angle can be adjusted freely.

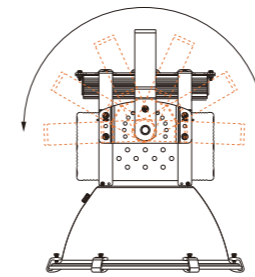

Respirator design

Waterproof design, eliminating mist, avoiding condensation, high quality, extending the life span.

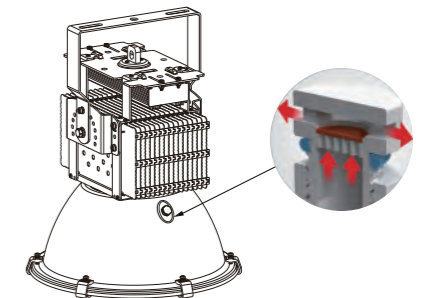

Reflector reflection rate is up to 92%

The Angle of the reflective 25°, 45°, 60°, 90°, reflection rate is up to 92%.

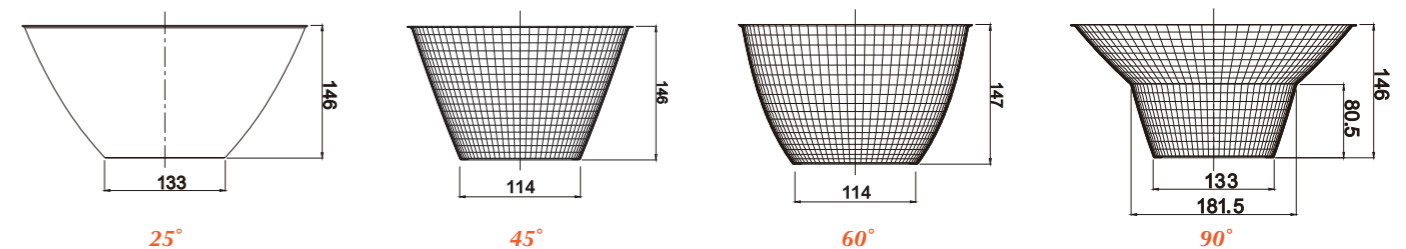

Production Introduction

MICA series led flood light use high quality SMD3030 LED chip and Taiwan Meanwell UL Driver. With aluminum heat fin design + copper heat pipes, the best heat dissipation performance on the market. This product is widely used for golf course, stadium, square, building docks, workshop etc.

LED FLOOD LIGHT

LIGHT THE WORLD



Certification: CE,ROHS,TUV,FCC,SAA,C-tick



ITEM No.	MFL-T150	MFL-T200	MFL-T300	MFL-T400
Led Power	150W	200W	300W	400W
Lumen Output	15000lm	20000lm	30000lm	40000lm
Weight	7.5kg	7.5kg	10kg	10kg
Product size(mm)	Dia370*347mm	Dia370*347mm	Dia369*356mm	Dia369*356mm
Carton size(mm)	440*440*330, 1pcs/CTN	440*440*330, 1pcs/CTN	440*440*330, 1pcs/CTN	440*440*330, 1pcs/CTN

ITEM No.	MFL-T500	MFL-T600	MFL-T800	MFL-T1000
Led Power	500W	600W	800W	1000W
Lumen Output	50000lm	60000lm	80000lm	100000lm
Weight	16.5kg	16.5kg	23kg	26kg
Product size(mm)	Dia471*407mm	Dia471*407mm	Dia472*496mm	Dia472*496mm
Carton size(mm)	550*550*360, 1pcs/CTN	550*550*360, 1pcs/CTN	630*530*450, 1pcs/CTN	630*550*450, 1pcs/CTN

LED FLOOD LIGHT

LIGHT THE WORLD



Beam angle	5 , 10, 20, 30, 60°	CRI	>80
Input Voltage	AC 85-300V	CCT	2700-6500k
Driver Brand	Meanwell driver	IP Grade	IP66
Led Lamp	XTE , XML2 , XHP50	Power Factor	>0.95

Product structure

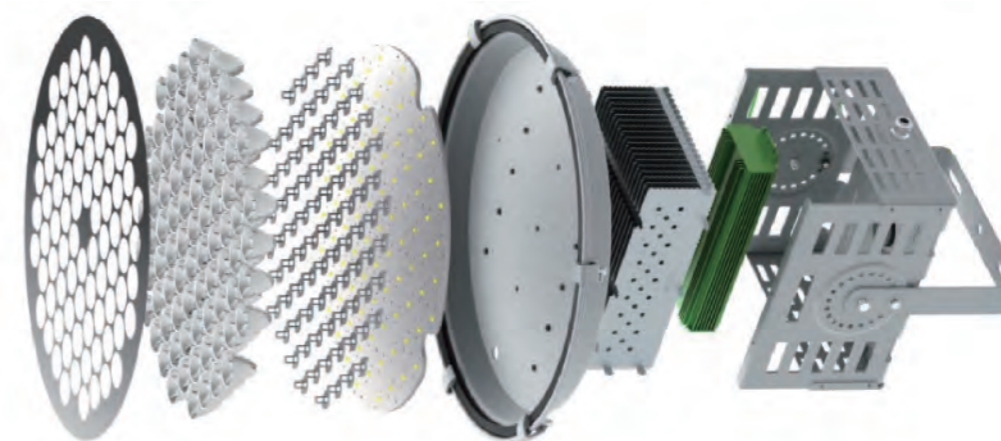

Reflector

5/10/20/30/60 degree beam angle reflector for optional, with surface polishing anodic oxidation treatment

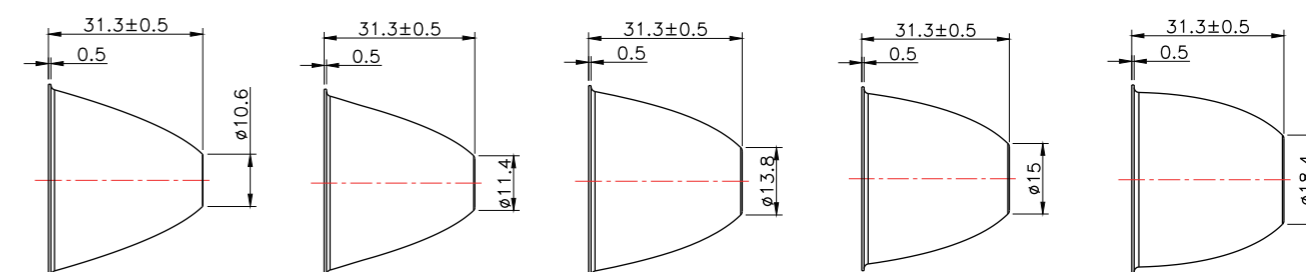

5°

10°

20°

30°

60°

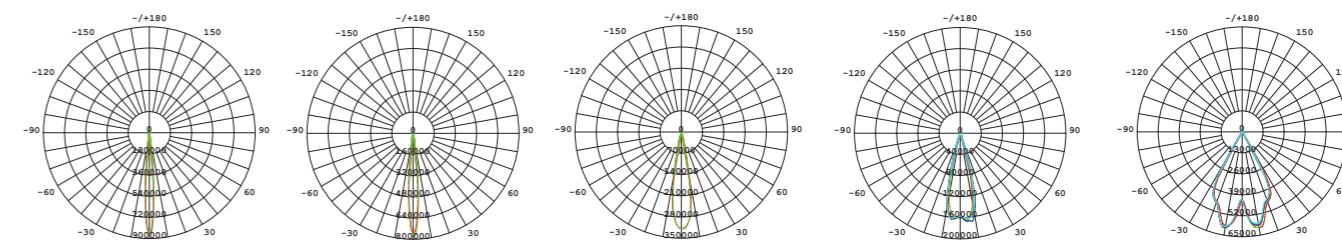

LED FLOOD LIGHT

LIGHT THE WORLD



Certification: CE,ROHS,TUV,FCC,SAA,C-tick



ITEM No.	MFL-G120	MFL-G240	MFL-G360	MFL-G480
Led Power	120W	240W	360W	480W
Lumen Output	19200lm	38400lm	57600lm	76800lm
NW&GW(kg)	2.8 & 3.3	5.6 & 6.2	7.25 & 8	11 & 11.95
Product size(mm)	W310*L116*H132	W362*L343*H132	W362*L475*H132	W362*L597*H132
Carton size(mm)	370*270*180, 1pcs/CTN	410*380*180, 1pcs/CTN	520*410*180, 1pcs/CTN	640*410*180, 1pcs/CTN

ITEM No.	MFL-G720	MFL-G960	MFL-G1200	MFL-G1440
Led Power	720W	960W	1200W	1440W
Lumen Output	115200lm	153600lm	192000lm	230400lm
NW&GW(kg)	16.8 & 18.7	18 & 23	27.2 & 29	33.5 & 35
Product size(mm)	W362*L861*H132	W649*L597*H132	W649*L729*H132	W649*L861*H132
Carton size(mm)	780*410*180, 1pcs/CTN	700*650*180, 1pcs/CTN	780*700*180, 1pcs/CTN	910*690*180, 1pcs/CTN

LED FLOOD LIGHT

LIGHT THE WORLD



Beam angle	20 , 40, 60, 90, 140*100°	CRI	>80
Input Voltage	AC 85-305V	CCT	2700-6500k
Driver Brand	Meanwell driver	IP Grade	IP65
Led Lamp	SMD 5050	Power Factor	>0.95

Bracket 180° adjustable

Each module is 30 degree separately adjustable, and the bracket is 180 degree adjustable.

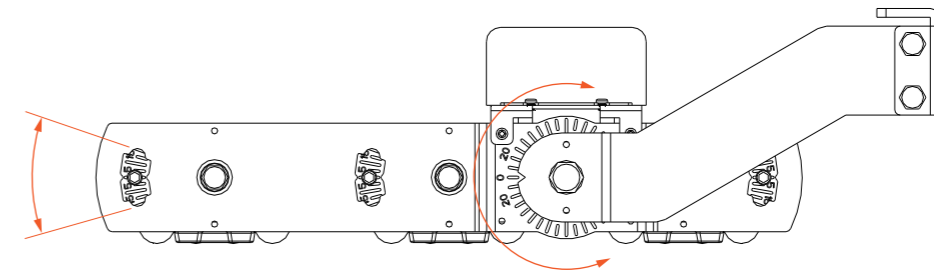

Multi-Angle lens

The lens for 20°, 40°, 60°, 90°, 140°*100° option, it is suit for multiple applications.

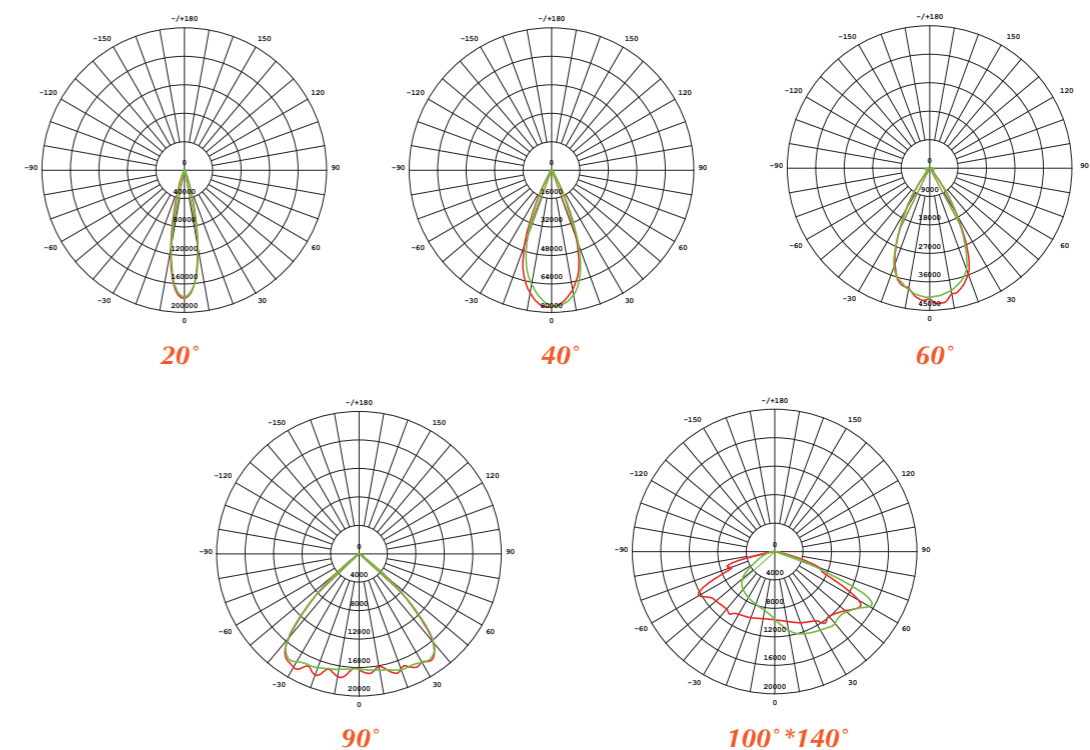

LED FLOOD LIGHT

LIGHT THE WORLD



Certification: CE,ROHS,TUV,FCC,SAA,C-tick



ITEM No.	MFL-G240-A	MFL-G360-A	MFL-G480-A	MFL-G600-A	MFL-G720-A
Led Power	240W	360W	480W	600W	720W
Lumen Output	38400lm	57600lm	76800lm	96000lm	115200lm
NW/GW/CBM(kg)	5.5&6.2	6.9&7.9&8.5	9.5&10.5&11	10.8&12&14	13&14.5&16
Product size(mm)	W250*L332*H180	W480*L350*H180	W628*L350*H180	W776*L350*H180	W924*L350*H180
Carton size(mm)	370*360*230	500*370*230	640*370*230	780*370*230	920*370*230

ITEM No.	MFL-G480-C	MFL-G720-C	MFL-G960-C	MFL-G1200-C	MFL-G1440-C
Led Power	480W	720W	960W	1200W	1440W
Lumen Output	76800lm	115200lm	153600lm	192000lm	230400lm
NW/GW/CBM(kg)	11&12&13	15&17&18	17&20&22	24&26&27	31&34&34
Product size(mm)	W587*L338*H180	W587*L484*H180	W632*L587*H180	W780*L587*H180	W924*L587*H180
Carton size(mm)	640*410*240	640*560*240	710*640*240	860*640*240	1010*640*240

LED FLOOD LIGHT

LIGHT THE WORLD



Light Efficient	> 160lm/w	CRI	>80
Input Voltage	AC 85-305V	CCT	2700-6500k
Driver Brand	Meanwell driver	IP Grade	IP65
Led Lamp	PHILIPS SMD 5050	Power Factor	>0.95

Lens optional

Symmetrical PC lens: 8°/20°/40°/60°/90°, Asymmetrical PC lens: 100°×140°

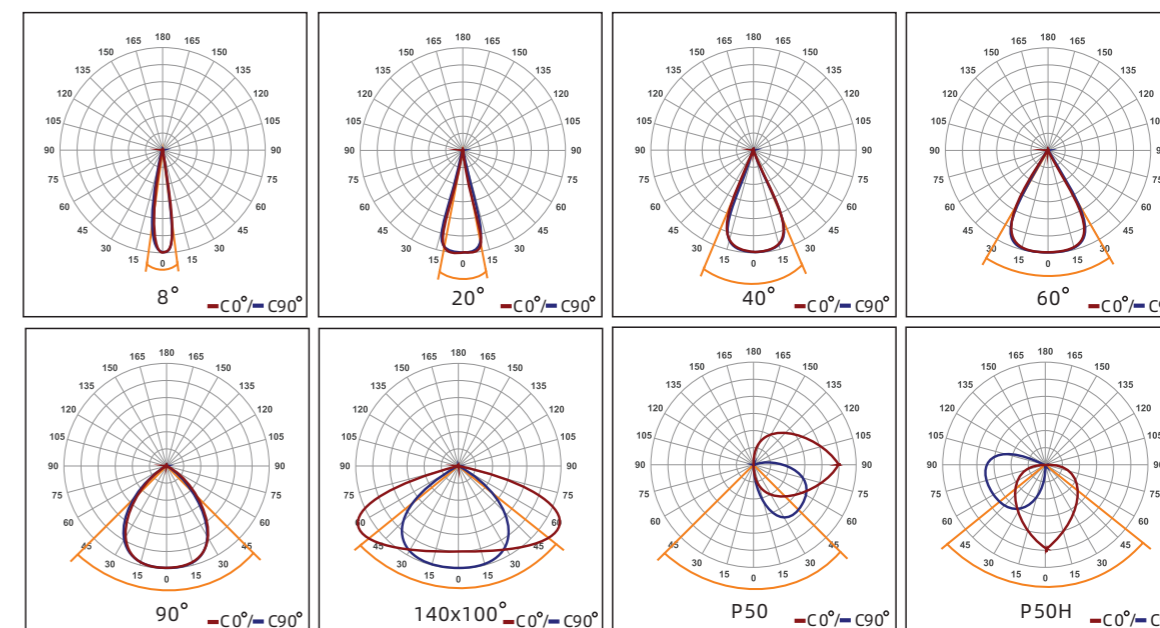

Advantage design of our Led flood light:

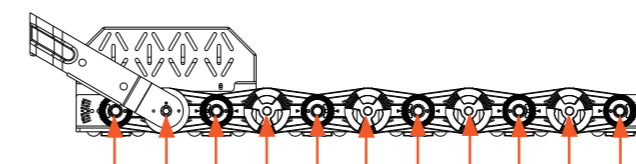

Where the Angle can be adjusted

1. MIC Folding heat sink used newest Stamping and twisting technology, Folding technology enlarge the dissipation area which make the heat fast to go out, which is 2 times much better than the diecasting aluminum or normal section bar heatsink in the market.
2. MIC folding heat sink used aviation aluminum -super thin which weight will be very light. For a same wattage light, our weight can 2 times less than compare normal design led light. So our lamp will be much more easy for installation, it will save your lamp pole's cost. And it will be more safe, it can stand strong hurricane.
3. MIC flood light's each single module's beam angle is adjustable, so user can adjust the angle easy without moving the bracket to get the best Uo, So when client install the lamp of us, they can easy to get Uo more than 0.9.
4. We had different installation adaptors optional, bracket use for flood light or slip fitter adaptor used for led street light.
5. Anti-glare mask can be installed.

LED FLOOD LIGHT

LIGHT THE WORLD



Certification: CE,ROHS,TUV,FCC,SAA,C-tick



ITEM No.	MFL-R300	MFL-R400	MFL-R500	MFL-R600	MFL-R800	MFL-R1000	MFL-R1200
Led Power	300W	400W	500W	600W	800W	1000W	300W
Lumen Output	39000lm	52000lm	65000lm	78000lm	104000lm	130000lm	156000lm
Weight	9kg	15kg	16kg	17kg	23kg	37kg	39kg
Product size(mm)	463*376*220	572*480*324	572*480*324	572*480*324	652*656*352	730*640*390	730*640*390
Carton size(mm)	425*425*220	660*610*240	660*610*240	660*610*240	682*612*245	760*680*290	760*680*290



Beam angle	15 & 35°	CRI	>80
Input Voltage	AC 85-300V & 180-528V	CCT	2700-6500k
Driver Brand	Meanwell driver	IP Grade	IP65
Led Lamp	PHILIPS SMD 3030	Power Factor	>0.95

LED FLOOD LIGHT

LIGHT THE WORLD

Production Introduction

MIC R series led flood light use high quality SMD3030 LED chip and Taiwan Meanwell UL Driver. Adopts integrated die-casting aluminum housing design, with excellent dissipation performance. This product is widely used for golf course, stadium, square, building docks, workshop etc.

Bracket 180° adjustable

Mounting Bracket is 180° adjustable, easy for installation

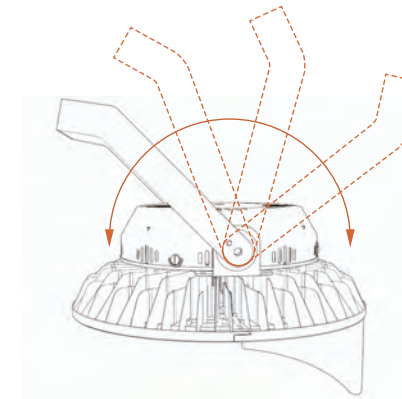

Respirator design

Waterproof design, eliminating mist, avoiding condensation, improving quality, extending the life span.

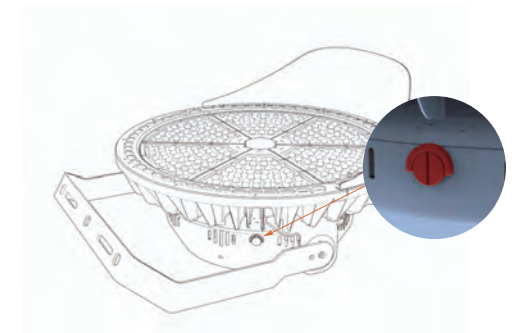

Product structure

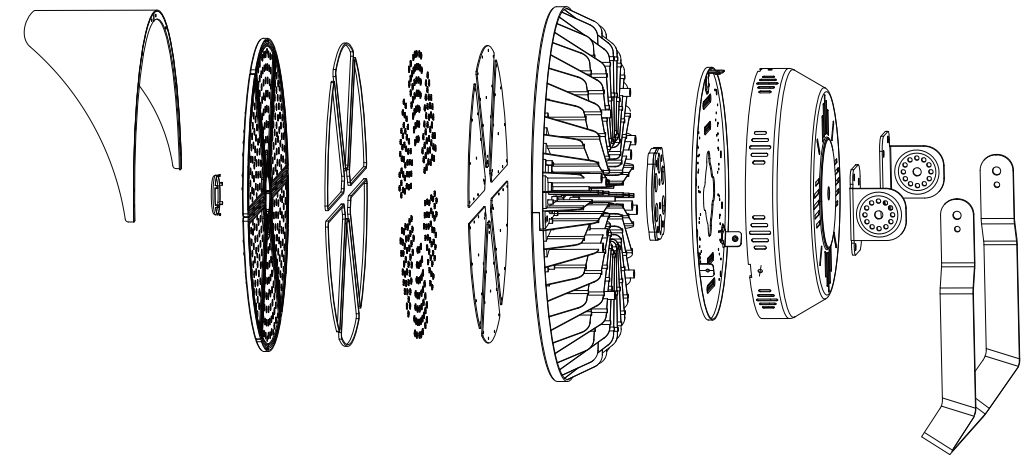

Warning

1. Please hire qualified person or professional installation company to install the light.
2. Please check the local voltage range is correspond with the working voltage of the light before installation.
3. Examine product carefully after open the carton. If it's damaged, please contact us.
4. Make sure the power supply has been cut off before maintenance or installation the lamp. After confirm the power cord is properly installed, the power can be turn on.
5. Make sure there is a good ventilation environment around the lamp. Keep the light out of fire, electrical shock or vibration.

LED FLOOD LIGHT

LIGHT THE WORLD



Certification: CE,ROHS,TUV,FCC,SAA,C-tick



ITEM No.	MFL-M100	MFL-M150	MFL-M200	MFL-M240
Led Power	100W	150W	200W	240W
Lumen Output	>13000lm	>19500lm	>26000lm	>31200lm
NW/GW	2 & 6kg	2.5 & 7kg	3.5 & 9kg	4.3 & 10kg
Product size(mm)	326.6*275*116.8	326.6*351*116.8	326.6*428*116.8	326.6*505*116.8
Carton size(mm)	41*39*20cm(2pcs/CTN)	48*39*20cm(2pcs/CTN)	56*39*20cm(2pcs/CTN)	66*39*20cm(2pcs/CTN)

Beam angle	15°, 25°, 40°, 60°, 90°, 120° & 30°*70°, 49°*21°, 136°*78°
Input Voltage	AC 85-305V
Driver Brand	CEI/Meanwell driver
Led Lamp	PHILIPS SMD 3030
CRI	>80
CCT	2700-6500k
IP Grade	IP65
Power Factor	>0.95

LED FLOOD LIGHT

LIGHT THE WORLD

Spectrum (Three lens available)

Beam angle: Symmetrical(15°/25°/40°/60°/90°/120°); Asymmetrical(30°*70°/49°*21°/136°*78°).

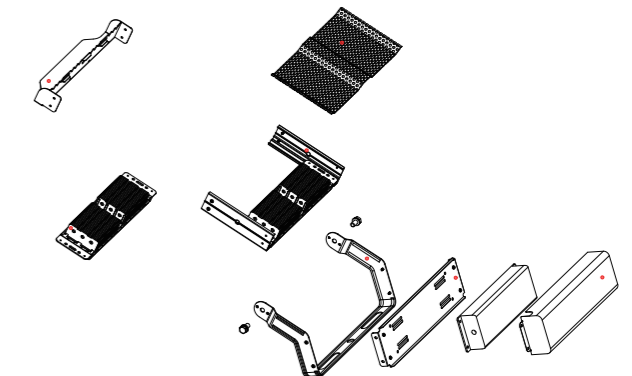
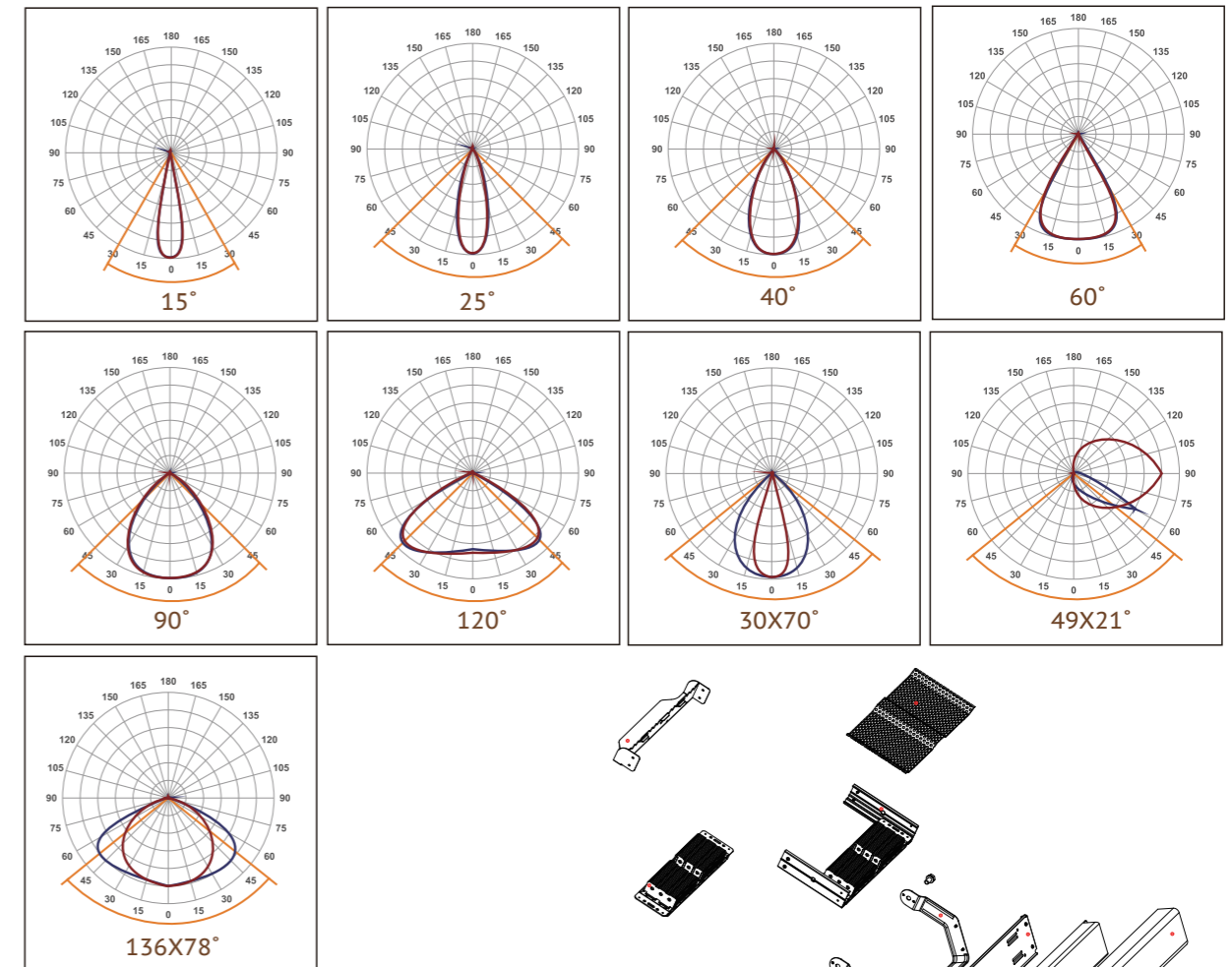

Explosion structure

Product Features

- Using high bright PHILIPS SMD 3030 .
- Modular designed, easy for maintenance.
- Folding heat sink used newest Stamping and twisting technology, Folding technology enlarge the dissipation area which make the heat fast to go out, which is 2 times much better than the diecasting aluminum or normal section bar heatsink in the market
- Folding heat sink used aviation aluminum -super thin and the weight is super light.
- The luminaire surface is with UV-resistant and anti-corrosive treatment, and the overall luminaire meets the IP65 standard.

LED FLOOD LIGHT

LIGHT THE WORLD



Certification: CE,ROHS,TUV,FCC,SAA,C-tick



ITEM No.	MFL-D300	MFL-D400	MFL-D500	MFL-D600
Led Power	300W	400W	500W	600W
Lumen Output	45000lm	60000lm	75000lm	90000lm
NW/GW(kg)	10.5 & 12	10.5 & 12	15 & 16	15 & 16
Product size(mm)	W531*L377*H229	W531*L377*H229	W637*L462*H264	W637*L462*H264
Carton size(mm)	558*432*172	558*432*172	672*534*188	672*534*188

ITEM No.	MFL-D800	MFL-D1000	MFL-D1200	MFL-D1500	MFL-D1800
Led Power	800W	1000W	1200W	1500W	1800W
Lumen Output	120000lm	150000lm	180000lm	225000lm	270000lm
NW/GW(kg)	23 & 24	32 & 33	32 & 33	47 & 49	47 & 49
Product size(mm)	W763*L593*H282	W869*L678*H282	W869*L678*H282	W1267*L678*H282	W1267*L678*H282
Carton size(mm)	826*633*198	932*718*198	932*718*198	1330*718*198	1330*718*198

LED FLOOD LIGHT

LIGHT THE WORLD



Light Efficient	> 150lm/w	CRI	>80
Input Voltage	AC 85-305V	CCT	2700-6500k
Driver Brand	Meanwell driver	IP Grade	IP66
Led Lamp	PHILIPS SMD 3030	Power Factor	>0.95

Lens optional

Symmetrical PC lens: 7°/15°/30°/40°/60°/90°, Asymmetrical PC lens: T2M/T3M/T4M.

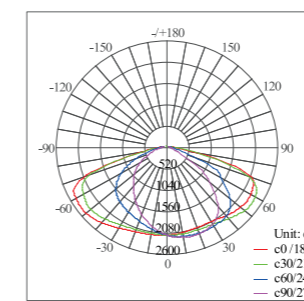

T2M

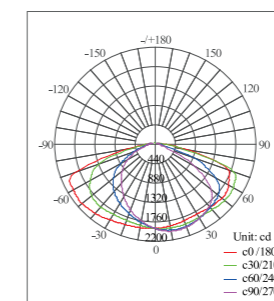

T3M

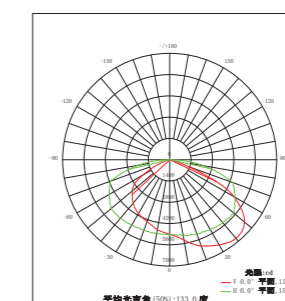

T4M

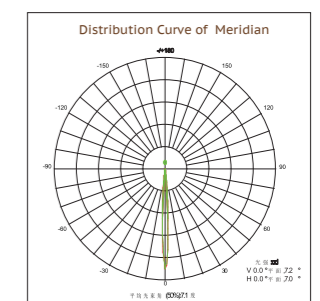

7°

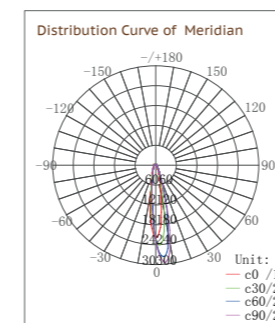

15°

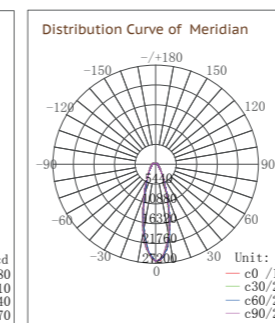

30°

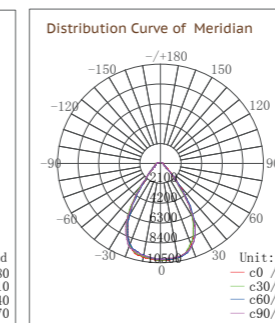

40°

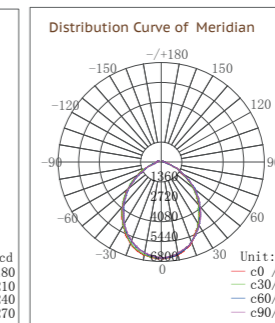

60°

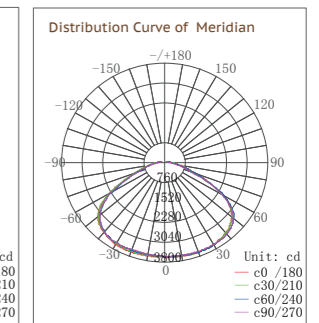

90°

Installation diagram

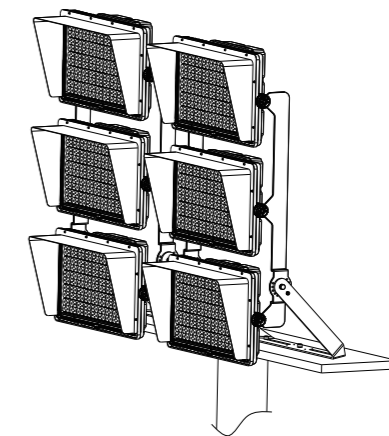
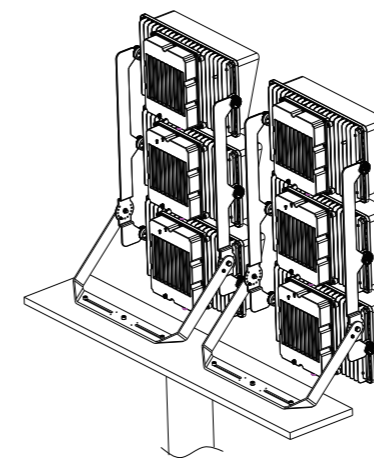

LED FLOOD LIGHT

LIGHT THE WORLD



Certification: CE,ROHS,TUV,FCC,SAA,C-tick



ITEM No.	MFL-S50-2	MFL-S100-2
Led Power	50W	100W
Lumen Output	8000lm	16000lm
NW/GW(kg)	2 & 2.1	2.5 & 2.6
Product size(mm)	317*254*47	317*305*47
Carton size(mm)	540*340*310mm, 10pcs/CTN	640*350*310mm, 10pcs/CTN

Light Efficient	> 160lm/w	CRI	>80
Input Voltage	AC 90-277V	CCT	2700-6500k
Driver Brand	Meanwell driver	IP Grade	IP66
Led Lamp	PHILIPS SMD 3030	Motion sensor	Yes

LED FLOOD LIGHT

LIGHT THE WORLD

Beam angle

8 different beam angle for option

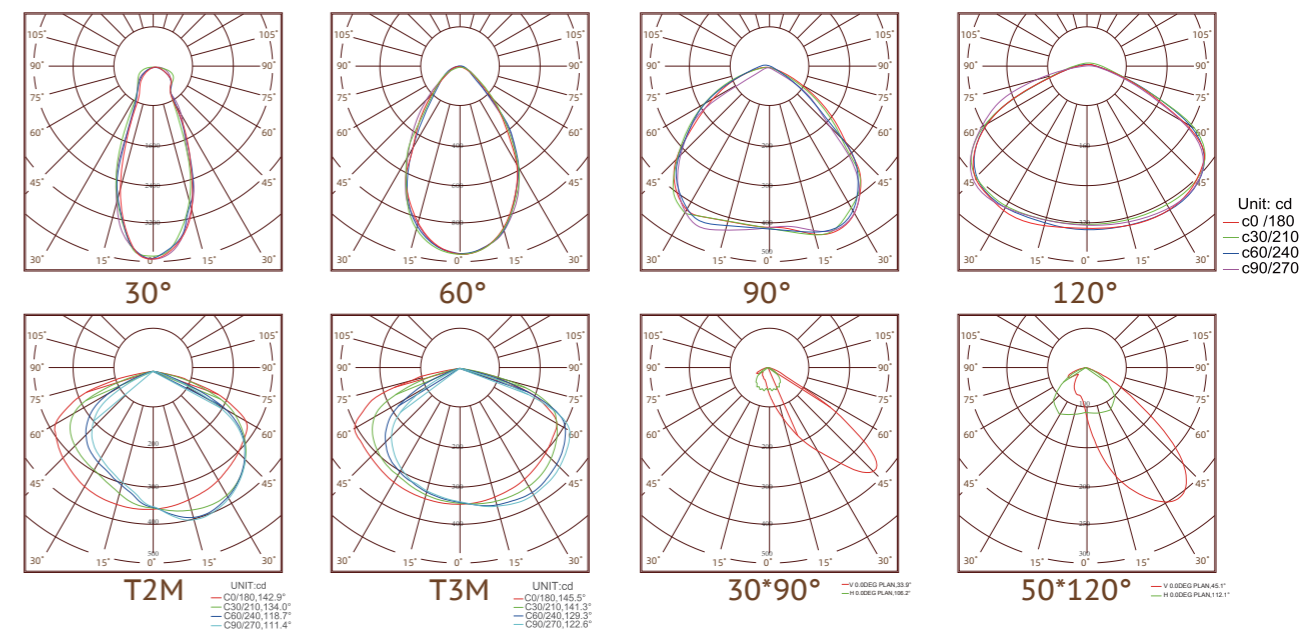

12VDC Highbay Sensor, Dimmable Function

- On/Off Control
- Detection Area
- Daylight Sensor
- 5 years Warranty
- Stand-by period
- Stand-by dimming level
- Hold Time
- 12M Highbay
- Remote Control

Detection Patterns

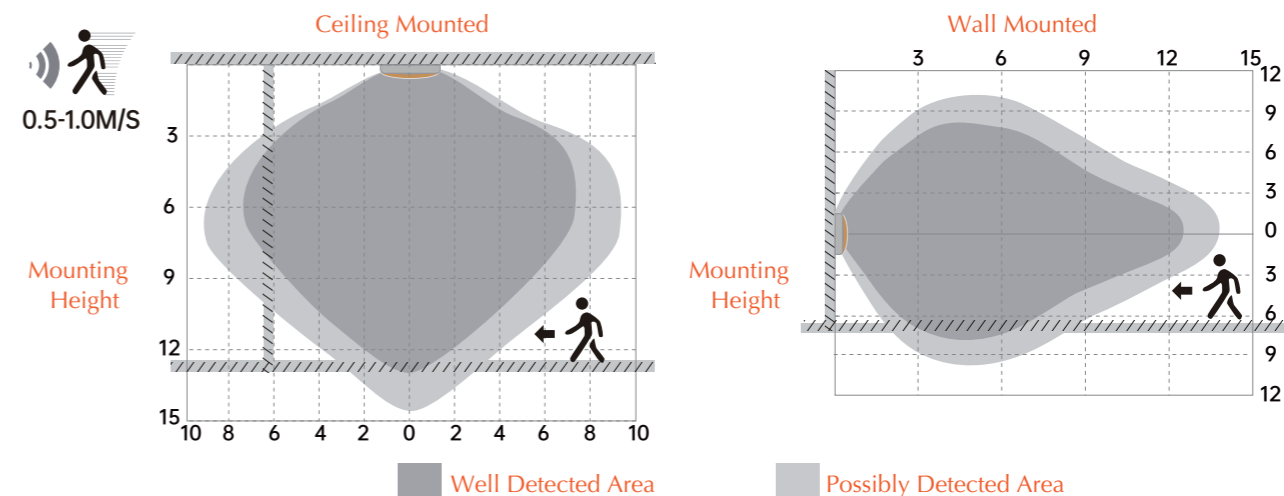

Highest mounting height is 12m
 This figure indicates the maximum distance at the highest mounting height with 100% sensitivity.

LED FLOOD LIGHT

LIGHT THE WORLD

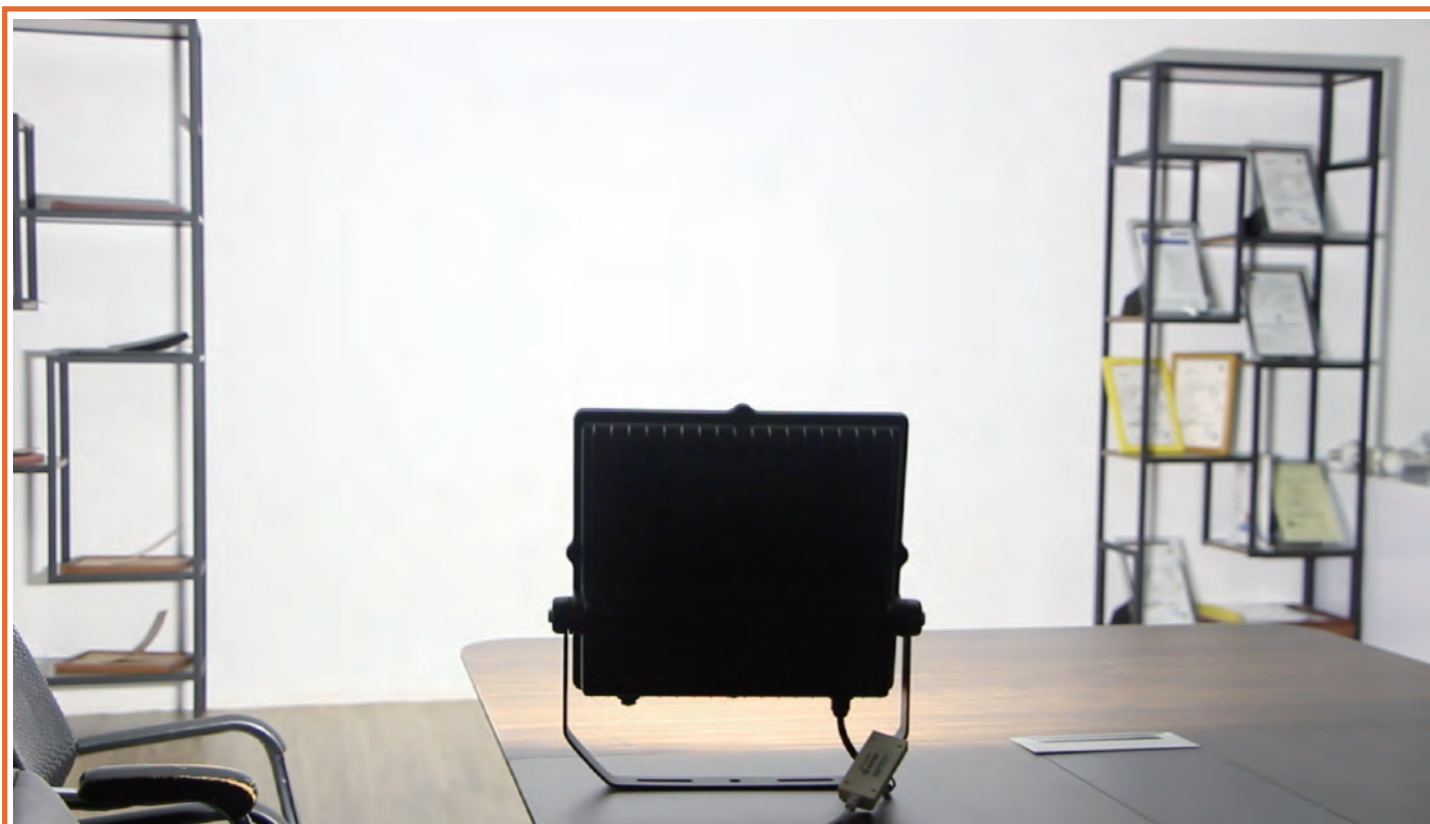

Certification: CE,ROHS,TUV,FCC,SAA,C-tick



ITEM No.	MFL-S10-I	MFL-S20-I	MFL-S30-I	MFL-S50-I
Led Power	10W	20W	30W	50W
Lumen Output	1300lm	2600lm	3900lm	6500lm
NW/GW(kg)	0.5 & 0.6	1 & 1.1	1.5 & 1.6	1.6 & 1.7
Product size(mm)	182*122*47	242*169*51	282*220*52	282*220*52
Carton size(mm)	395*270*290mm,20pcs/CTN	510*365*315mm,20pcs/CTN	465*305*315mm,10pcs/CTN	465*305*315mm,10pcs/CTN

ITEM No.	MFL-S80-I	MFL-S100-I	MFL-S150-I	MFL-S200-I
Led Power	80W	100W	150W	200W
Lumen Output	10400lm	13000lm	19500lm	26000lm
NW/GW(kg)	2.2 & 2.3	4.2 & 4.4	5 & 5.4	6 & 6.5
Product size(mm)	337*269*52	394*394*56	445*392*56	497*392*56
Carton size(mm)	588*360*315mm,10pcs/CTN	440*420*115mm,1pcs/CTN	490*420*115mm,1pcs/CTN	540*420*115mm,1pcs/CTN

LED FLOOD LIGHT

LIGHT THE WORLD



Light Efficient	> 130lm/w	CRI	>80
Input Voltage	AC 85-305V DC 12-24V	CCT	2700-6500k
Driver Brand	Meanwell driver	IP Grade	IP66
Led Lamp	PHILIPS SMD 3030 & 5050	Power Factor	>0.95

Spectrum (9 different beam angle for option)

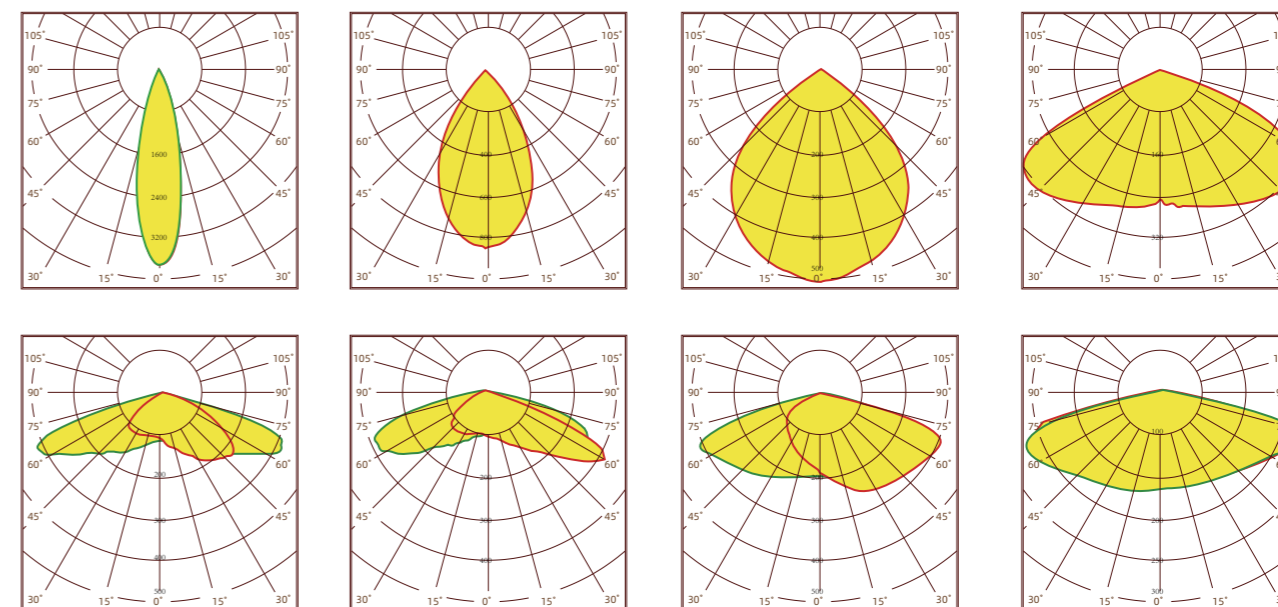

Installation Instruction for 85-300V/347V

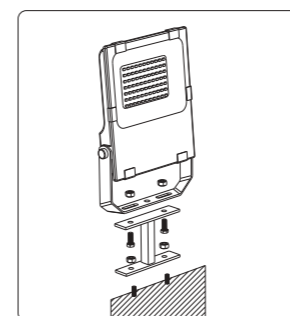

1. Install the lamp by the stand on the ground

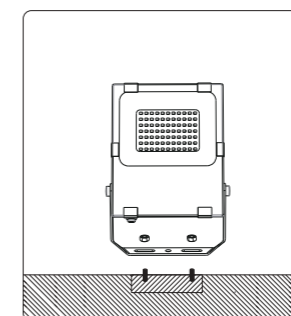

2. Install lamp directly

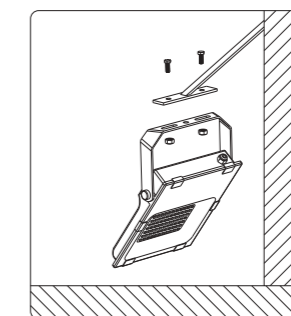

3. Hang the lamp by the stand

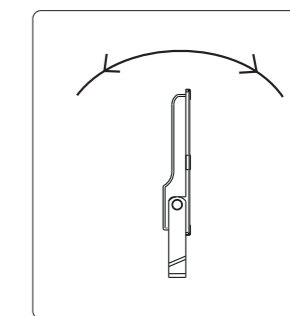

4. The angle of the lamp is adjustable

LED TUNNEL LIGHT

LIGHT THE WORLD

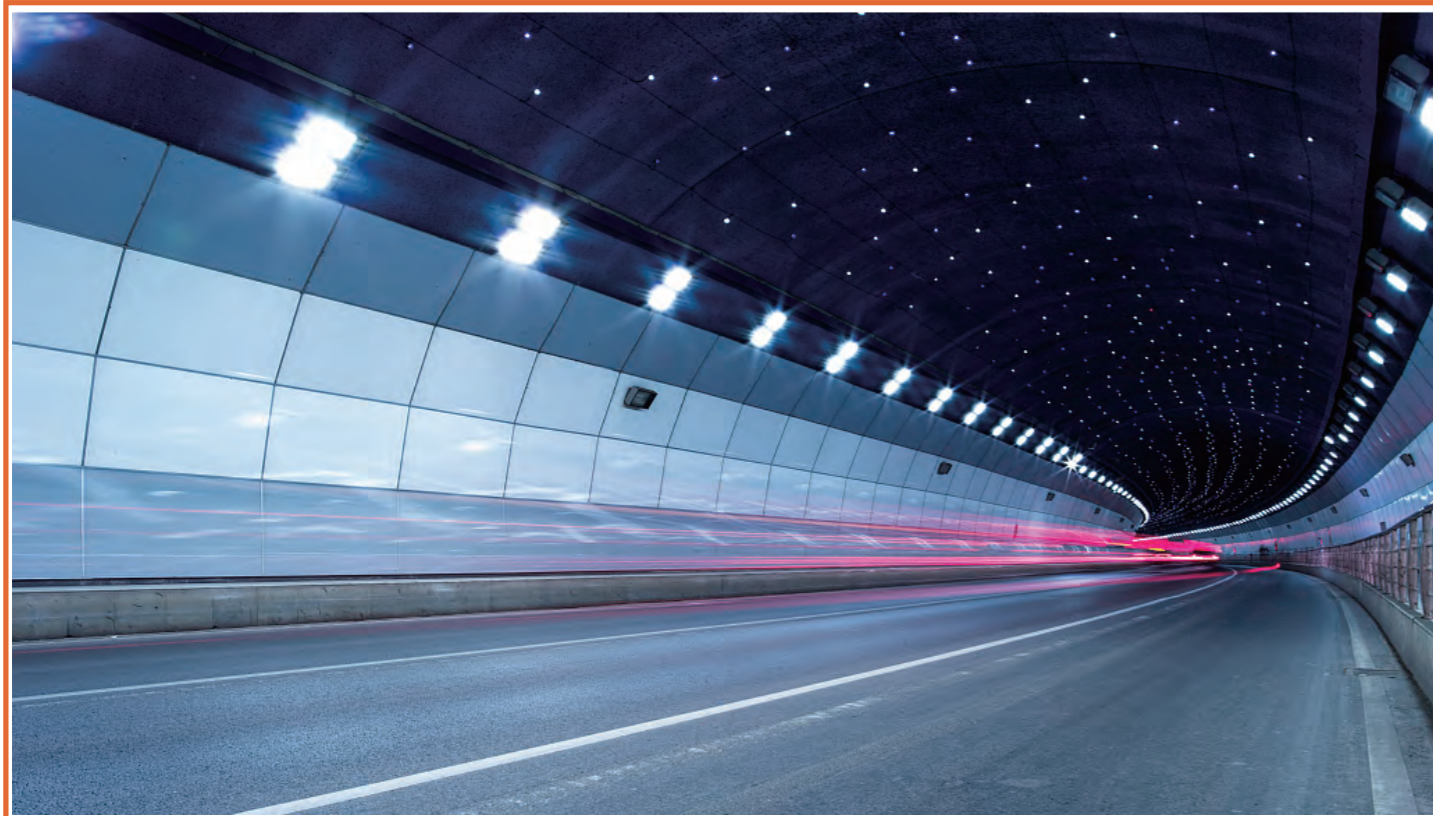

Certification: CE,ROHS,TUV,FCC,SAA,C-tick

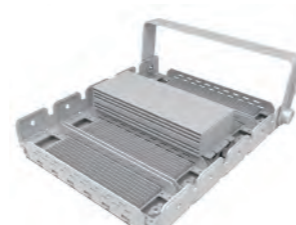

ITEM No.	MT-C30	MT-C40	MT-C60	MT-C90	MT-C120
Led Power	30W	40W	60W	90W	120W
Lumen Output	3900lm	5200lm	7800lm	11700lm	15600lm
NW/GW	4kg/5kg	4kg/5kg	4kg/5kg	6.5kg/8kg	6.5kg/8kg
Product size(mm)	337*137*80	337*137*80	337*137*80	337*221*82	337*221*82
Carton size(mm)	480*360*330, 12pcs/CTN	480*360*330, 12pcs/CTN	480*360*330, 12pcs/CTN	360*360*470, 8pcs/CTN	360*360*470, 8pcs/CTN

ITEM No.	MT-C150	MT-C180	MT-C210	MT-C240	MT-C300
Led Power	150W	180W	210W	240W	300W
Lumen Output	19500lm	23400lm	27300lm	31200lm	39000lm
NW/GW	6.5kg/8kg	6.5kg/8kg	8.5kg/10.5kg	8.5kg/10.5kg	9.5kg/11.5kg
Product size(mm)	337*287*82	337*287*82	337*362*82	337*362*82	337*437*87
Carton size(mm)	360*315*350, 4pcs/CTN	360*315*350, 4pcs/CTN	355*355*400, 4pcs/CTN	355*355*400, 4pcs/CTN	335*335*475, 4pcs/CTN

LED TUNNEL LIGHT

LIGHT THE WORLD



Beam angle	60°*60°, 90°*90°, 90°*100°	CRI	>80
Input Voltage	85-277V AC,	CCT	2700-6500k
Driver Brand	CE/Meanwell driver	IP Grade	IP67
Led Lamp	PHILIPS SMD 3030	Power Factor	>0.95

Multi-Angle lens

The lens for 60°, 90° and 90°*100° option, it is suit for multiple applications.

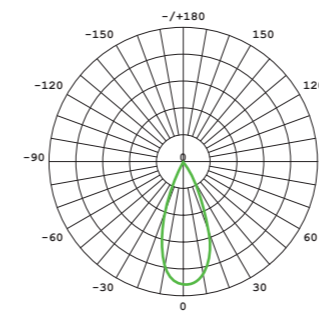

60°

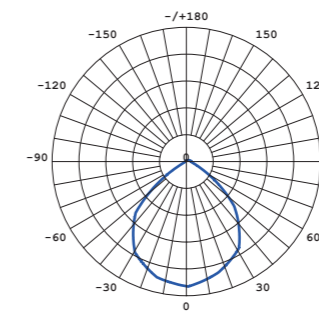

90°

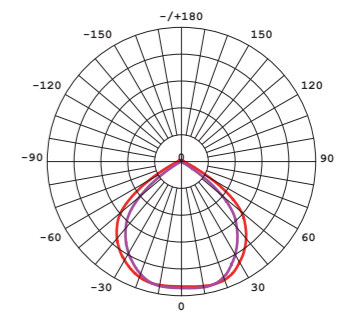

90°*100°

Modular design

Modular design, it is convenient for maintenance and assembly.

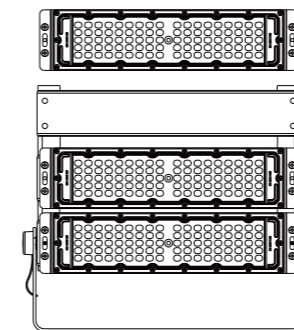

Installation way

The bracket with adjustable installation angle. multi-holes for installation optional. it can be flexibly to adjust the angles according to different requirements and applications.

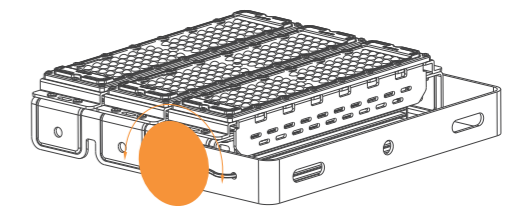

1060 Aluminum

Made of aviation aluminum, highly corrosion resistant and high thermal conductivity and outstanding performance. with excellent thermal conduction to the effect that ordinary aluminum alloy can not meet.

LED SHOEBOX LIGHT

LIGHT THE WORLD



Certification: UL,CE,ROHS,TUV,FCC,SAA,C-tick



ITEM No.	ST01-XX01-60	ST01-XX01	ST01-XX01-01
Led Power	60W	100W	150W
Lumen Output	7800lm	13000lm	19500lm
NW/GW	8.7kg/10kg	6.1kg/7kg	6.2kg/7.1kg
Product size(mm)	300*300*70	535*316*70	535*316*70
Carton size(mm)	370*370*175, 1pcs/CTN	605*309*140, 1pcs/CTN	605*390*140, 1pcs/CTN

ITEM No.	ST02-XX01	ST03-XX01
Led Power	240W	300W
Lumen Output	31200lm	39000lm
NW/GW	8.7kg/10kg	9.7kg/11kg
Product size(mm)	626*316*70	710*316*70
Carton size(mm)	675*390*140, 1pcs/CTN	785*390*140, 1pcs/CTN

LED SHOEBOX LIGHT

LIGHT THE WORLD



Beam angle	TYPE II, TYPE III, TYPE V	CRI	>70
Input Voltage	AC 85-277V, 180-528V	CCT	2700-6500k
Driver Brand	CE/Meanwell UL driver	IP Grade	IP65
Led Lamp	PHILIPS SMD 3030	Power Factor	>0.95

Photocell Sensor Optional

Automatically switches a light on at dusk and off at dawn.

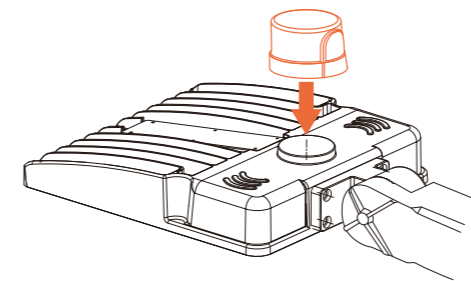

Microwave motion sensor design

The sensors can provide 2-step dimming function, 100%—> low light (Never turns off). They are particularly suitable for use in Urban roads, Industrial areas, Residential areas, Sidewalks, Parking lots, Schools, Gardens, the light will lighten when motion is detected.

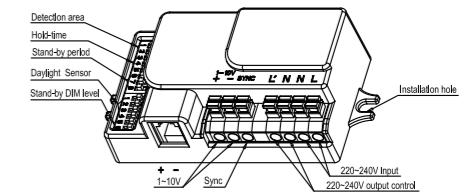

Installation method

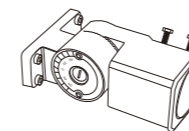

Slip Fitter

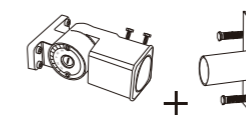

Adapter

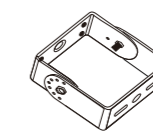

Trunion

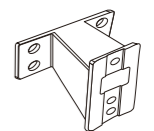

Arm

1.Slip Fitter

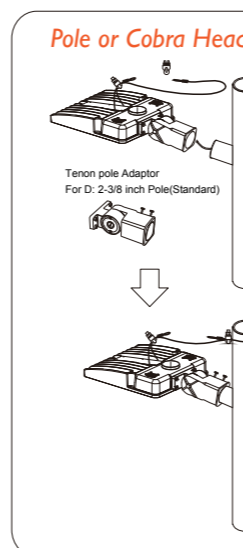

Square Pole

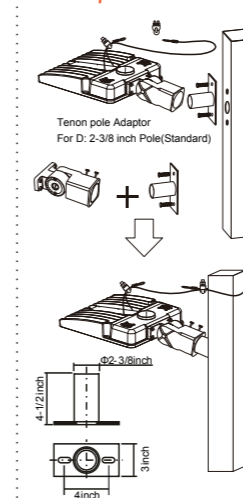

2.Trunion

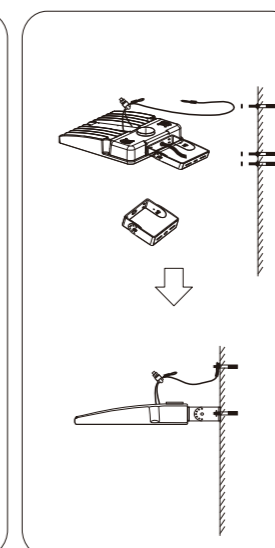

3.Arm

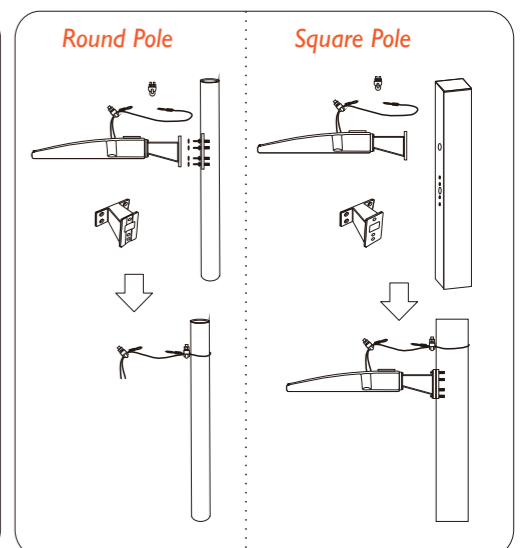

LED STREET LIGHT

LIGHT THE WORLD

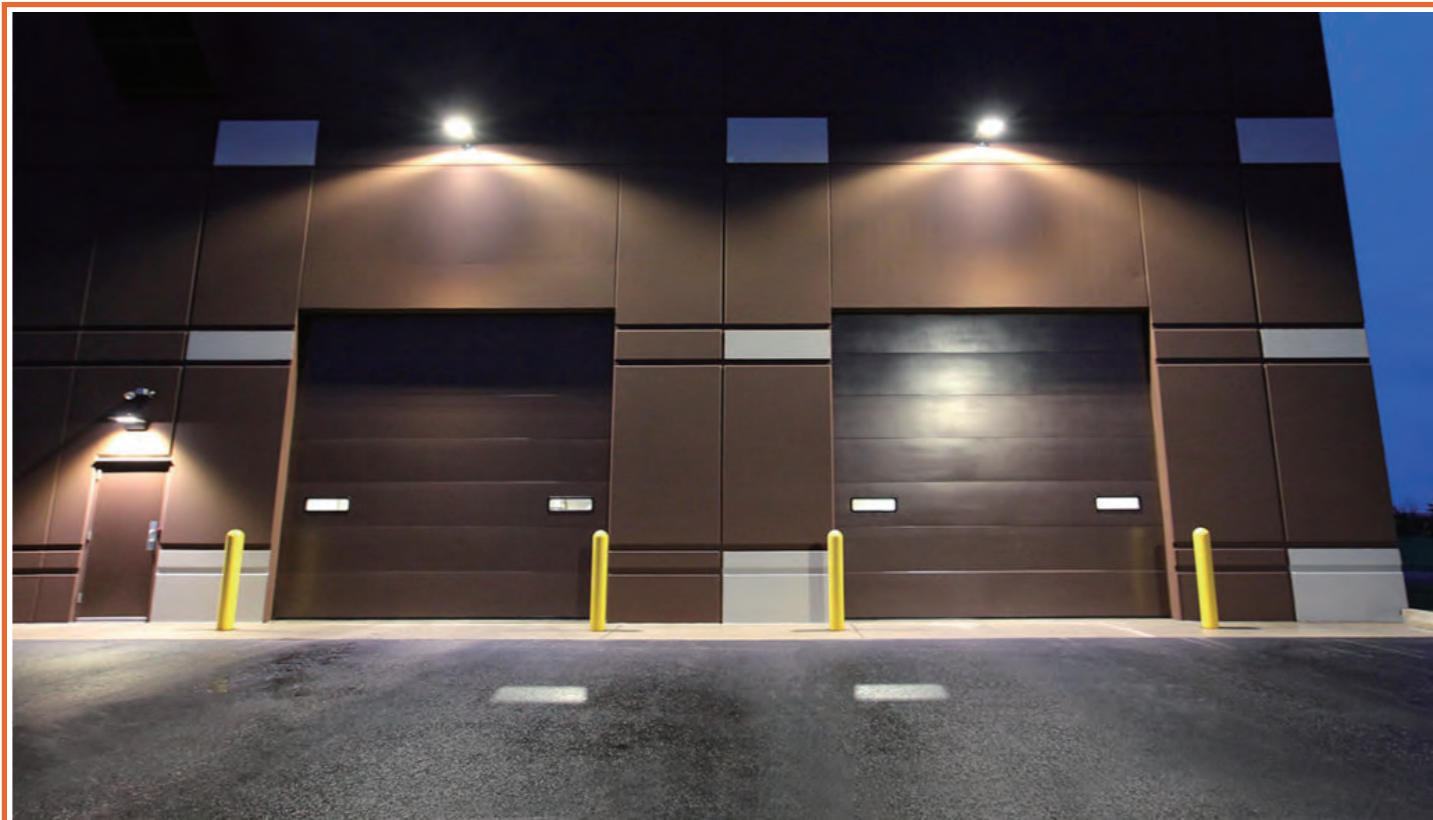

Certification: UL,CE,ROHS,TUV,FCC,SAA,C-tick

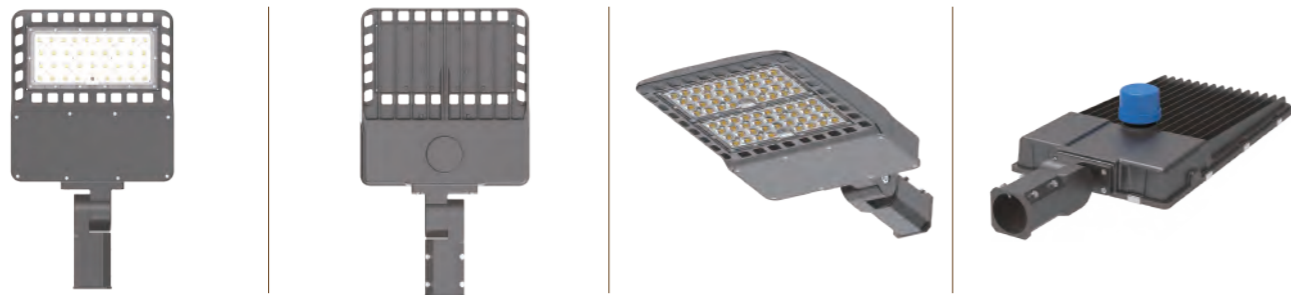

ITEM No.	MSL-D100	MSL-D150	MSL-D
Led Power	100W	150W	200W
Lumen Output	>13000lm	>19500lm	>26000lm
NW	4.7kg	4.8kg	5.6kg
Product size(mm)	543*317*75	543*317*75	663*317*75

ITEM No.	MSL-D240	MSL-D300
Led Power	240W	300W
Lumen Output	>31200lm	>39000lm
NW	6kg	6.8kg
Product size(mm)	663*317*75	785*317*84

LED STREET LIGHT

LIGHT THE WORLD



Beam angle	120°	CRI	>70
Input Voltage	AC 85-277V	CCT	2700-6500k
Driver Brand	CE/Meanwell UL driver	IP Grade	IP65
Led Lamp	PHILIPS SMD 3030	Power Factor	>0.95

Photocell Sensor Optional

Automatically switches a light on at dusk and off at dawn.

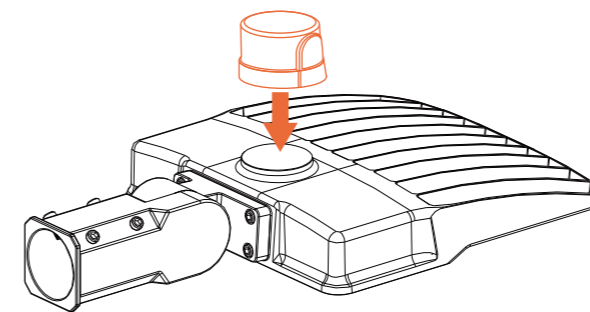

Microwave motion sensor design

The sensors can provide 2-step dimming function, 100% → low light (Never turns off). They are particularly suitable for use in Urban roads, Industrial areas, Residential areas, Sidewalks, Parking lots, Schools, Gardens, the light will lighten when motion is detected.

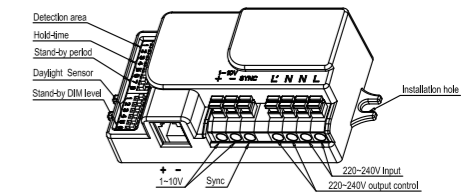

Installation method

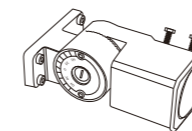

Slip Fitter

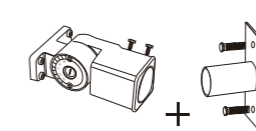

Adapter

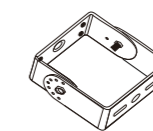

Trunnion

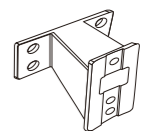

Arm

1.Slip Fitter

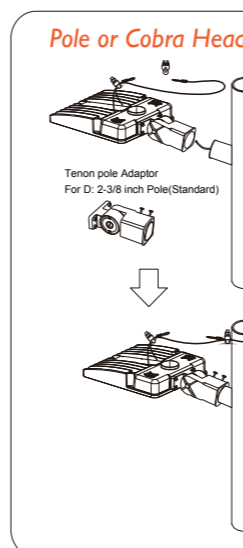

Square Pole

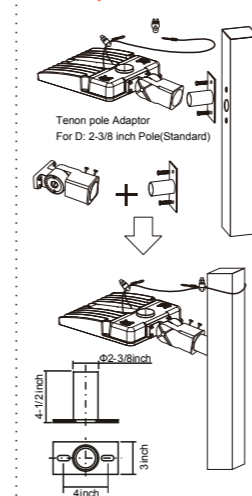

2.Trunnion

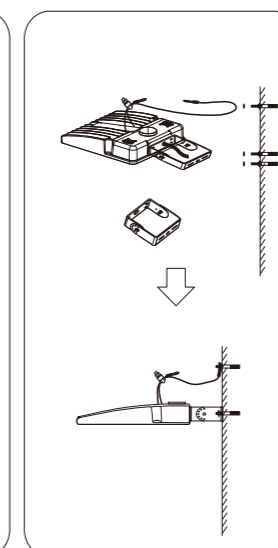

3.Arm

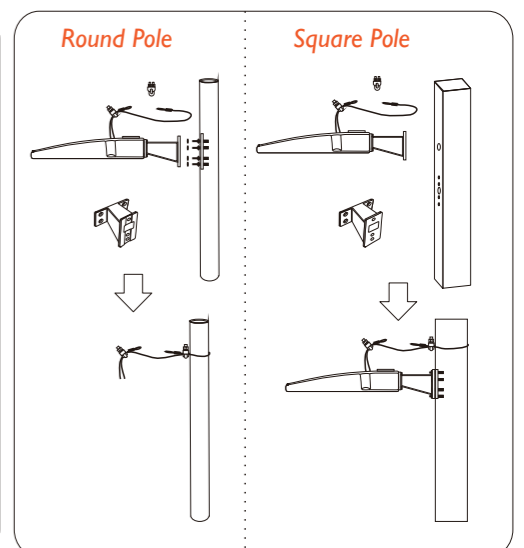

LED STREET LIGHT

LIGHT THE WORLD



Certification: CE,ROHS,TUV,FCC,SAA,C-tick



ITEM No.	MSL-S30	MSL-S40	MSL-S60
Led Power	30W	40W	60W
Lumen Output	3000lm	4000lm	6000lm
NW/GW	1.5kg/1.65kg	1.6kg/1.75kg	1.85kg/2.5kg
Product size(mm)	366*135*85	366*135*90	431*160*90
Carton size(mm)	420*200*160, 1pcs/CTN	420*200*160, 1pcs/CTN	480*230*160, 1pcs/CTN

ITEM No.	MSL-S90	MSL-S120	MSL-S150
Led Power	90W	120W	150W
Lumen Output	9000lm	12000lm	15000lm
NW/GW	2..85kg/3.65kg	3.78kg/4.68kg	5.4kg/6.4kg
Product size(mm)	431*160*90	632*215*90	632*215*90
Carton size(mm)	480*230*160, 1pcs/CTN	690*280*160, 1pcs/CTN	690*280*160, 1pcs/CTN

LED STREET LIGHT

LIGHT THE WORLD



Beam angle	75°*140°	CRI	>80
Input Voltage	85-264V/277V AC, 12V/24V DC	CCT	2700-6500k
Driver Brand	CE/Meanwell driver	IP Grade	IP65
Led Lamp	OSRAM SMD 3030	Power Factor	>0.95

Adjustable arm

180 degree adjustable arm available

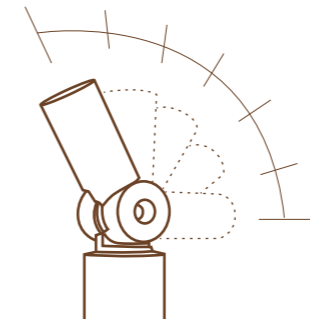

Integrated design

Integrated design of driver and arm, greatly reduce the size of lamp, to save more cost

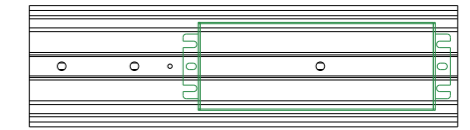

Two sizes for pole arm

Suitable for different size of arm; Easy for installation.

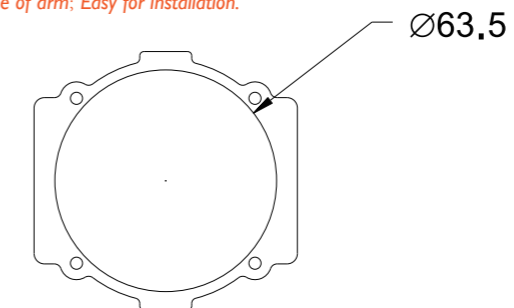

For arm diameter 60mm

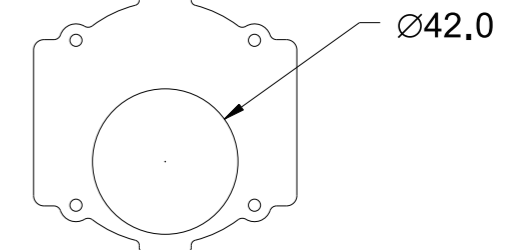

For arm diameter 40mm

Features

1. Adopt sheet metal technology, best heat dissipation performance;
2. Ultra Slim design, greatly reduce wind resistance;
3. Small size and light weight, low shipping and installation cost;
4. Functions of light control available, automatically turn on/off from at dusk/dawn.

LED STREET LIGHT

LIGHT THE WORLD



Certification: CE,ROHS,TUV,FCC,SAA,C-tick



ITEM No.	MSL-A50	MSL-A100	MSL-A150	MSL-A200
Led Power	50W	100W	150W	200W
Lumen Output	>8000lm	>16000lm	>24000lm	>32000lm
NW/GW	4kg/4.5kg	5kg/5.5kg	6.4kg/7kg	8.2kg/9kg
Product size(mm)	484*230*127	548*230*127	598*257*129	655*320*131
Carton size(mm)	417*264*155	482*272*160	542*302*160	612*372*185



Beam angle	120°	CRI	>80
Input Voltage	AC 85-300V & 347V	CCT	2700-6500k
Driver Brand	CE/Meanwell UL driver	IP Grade	IP65
Led Lamp	PHILIPS SMD 5050	Power Factor	>0.95

LED STREET LIGHT

LIGHT THE WORLD

Spectrum (Three lens available)

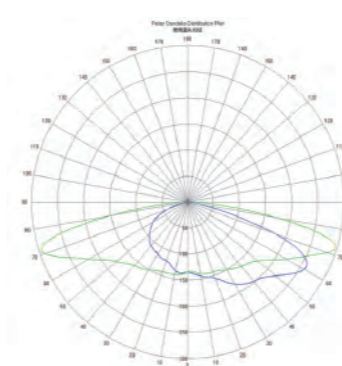

Type II

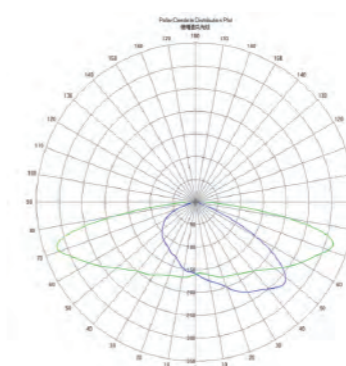

Type III

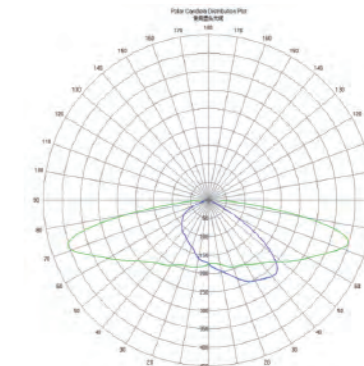

Type IV

Explosion structure

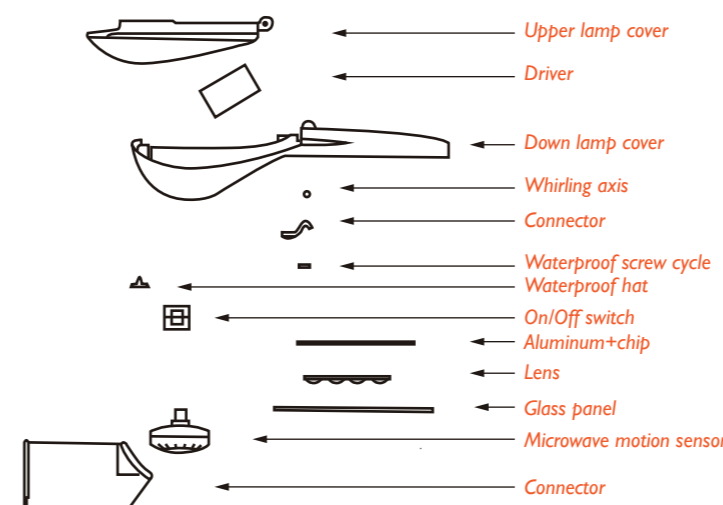

Sensor

The standard type is without sensor. Photocell & Microwave sensor is available if needed.



Product Features

- Using high bright SMD 3030 or SMD 5050.
- Adopts integrated design of heat sink and lamp housing. The LED is directly connected to the outer casing, and the heat dissipation fins transfer the light source heat out fast, which fully ensure the lifetime 50,000 hours of the LED street light.
- The lamp housing is made of die-casting aluminum, and the reasonable structure design ensure the effective heat dissipation performance, waterproof and dustproof. The luminaire surface is with UV-resis tant and anti-corrosive treatment, and the overall luminaire meets the IP66 standard.
- It adopts standard ADC12 die-casting aluminum, which is environmentally friendly and pollution-free. It does not contain lead, mercury and other pollution elements, and has no pollution to the environment.

LED STREET LIGHT

LIGHT THE WORLD



Certification: CE,ROHS,TUV,FCC,SAA,C-tick



ITEM No.	MSL-A25-I	MSL-A50-I	MSL-A80-I	MSL-A100-I	MSL-A120-I	MSL-A150-I
Led Power	25W	50W	80W	100W	120W	150W
Lumen Output	4000lm	8000lm	12800lm	16000lm	19200lm	24000lm
NW/GW(kg)	1.7&2.1	1.7&2.1	2.3&2.8	2.3&2.8	3&3.5	3&3.5
Product size(mm)	W408*L230*H106	W408*L230*H106	W509*L230*H106	W509*L230*H106	W600*L257*H109	W600*L257*H109
Carton size(mm)	420*260*150	420*260*150	520*260*150	520*260*150	620*287*150	620*287*150



Light Efficient	> 160lm/w	CRI	>80
Input Voltage	AC 85-305V DC 12-24V	CCT	2700-6500k
Driver Brand	Meanwell driver	IP Grade	IP66
Led Lamp	PHILIPS SMD 5050	Power Factor	>0.95

LED STREET LIGHT

LIGHT THE WORLD

Spectrum (Three lens available)

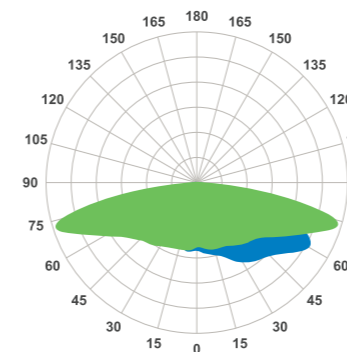

Type II

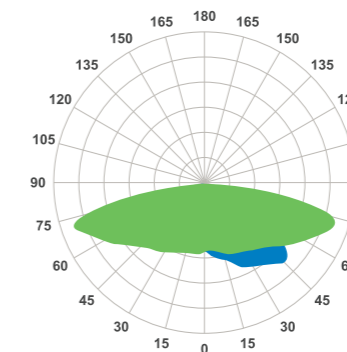

Type III

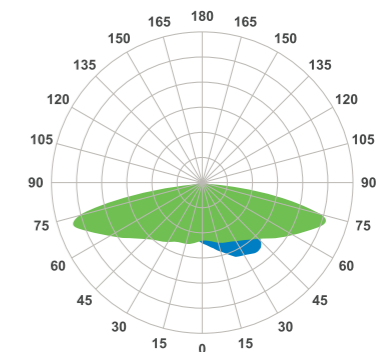

Type IV

Explosion structure

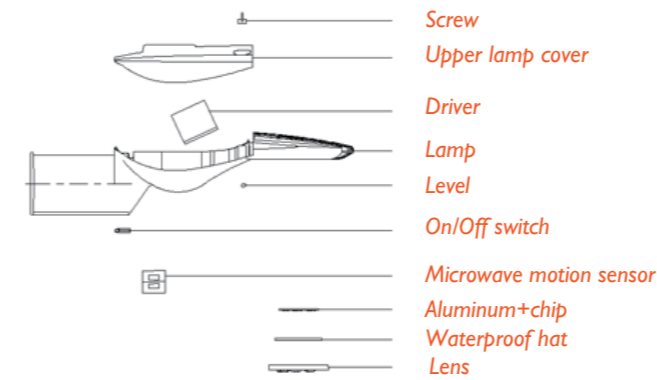

Sensor

The standard type is without sensor. Photocell & Microwave sensor is available if needed.

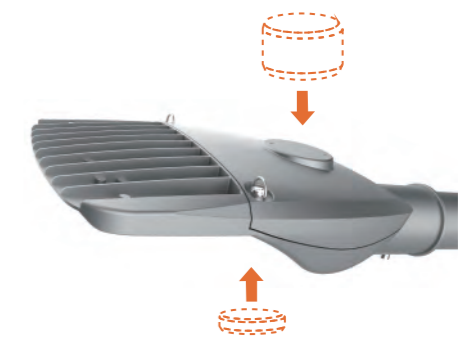

Product Features

- Using high bright SMD 3030 or SMD 5050.
- Adopts integrated design of heat sink and lamp housing. The LED is directly connected to the outer casing, and the heat dissipation fins transfer the light source heat out fast, which fully ensure the lifetime 50,000 hours of the LED street light.
- The lamp housing is made of die-casting aluminum, and the reasonable structure design ensure the effective heat dissipation performance, waterproof and dustproof. The luminaire surface is with UV-resis tant and anti-corrosive treatment, and the overall luminaire meets the IP66 standard.
- It adopts standard ADC12 die-casting aluminum, which is environmentally friendly and pollution-free. It does not contain lead, mercury and other pollution elements, and has no pollution to the environment.

LED STREET LIGHT

LIGHT THE WORLD



Certification: CE,ROHS,TUV,FCC,SAA,C-tick



ITEM No.	MSL-F30	MSL-F50	MSL-F60	MSL-F80	MSL-F100	MSL-F120
Led Power	30W	50W	60W	80W	100W	120W
Lumen Output	4200lm	7000lm	8400lm	11200lm	14000lm	16800lm
NW/GW(kg)	3.4 & 4.3	3.4 & 4.3	3.5 & 4.5	4.2 & 5.2	4.4 & 5.4	4.6 & 5.6
Product size(mm)	568*200*109	568*200*109	568*200*109	613*240*109	613*240*109	613*240*109
Carton size(mm)	623*255*170	623*255*170	623*255*170	623*255*170	623*255*170	623*255*170

ITEM No.	MSL-F150	MSL-F180	MSL-F200	MSL-F240	MSL-F300
Led Power	150W	180W	200W	240W	300W
Lumen Output	21000lm	25200lm	28000lm	33600lm	42000lm
NW/GW(kg)	5.1 & 6.1	5.4 & 6.4	6.2 & 7.2	6.5 & 7.5	7.2 & 8.2
Product size(mm)	683*260*109	683*260*109	693*300*109	693*300*109	793*300*109
Carton size(mm)	736*315*170	736*315*170	747*355*170	747*355*170	846*355*170

LED STREET LIGHT

LIGHT THE WORLD



Light Efficient	> 140 & 170 lm/w	CRI	>80
Input Voltage	AC 85-305V DC 12-24V	CCT	2700-6500k
Driver Brand	Meanwell driver	IP Grade	IP66
Led Lamp	PHILIPS SMD 3030 & 5050	Power Factor	>0.95

Gradienter

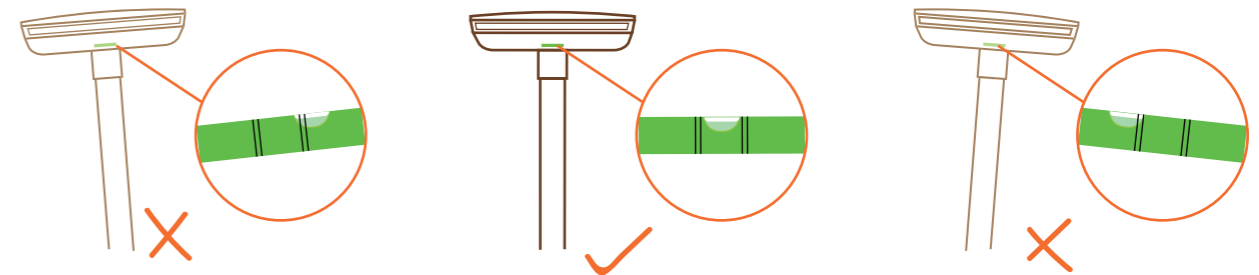

Spectrum (Four lens available)

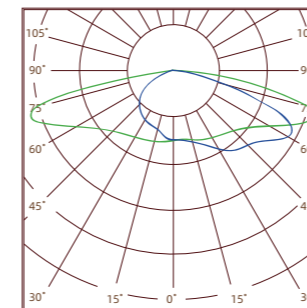

Type II

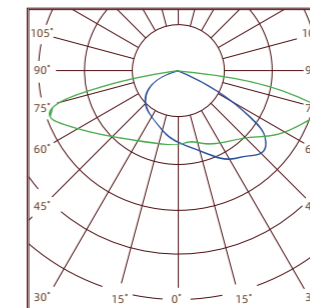

Type III

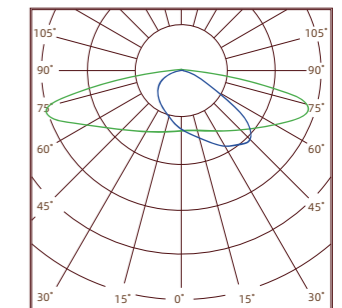

Type IV

Explosion structure

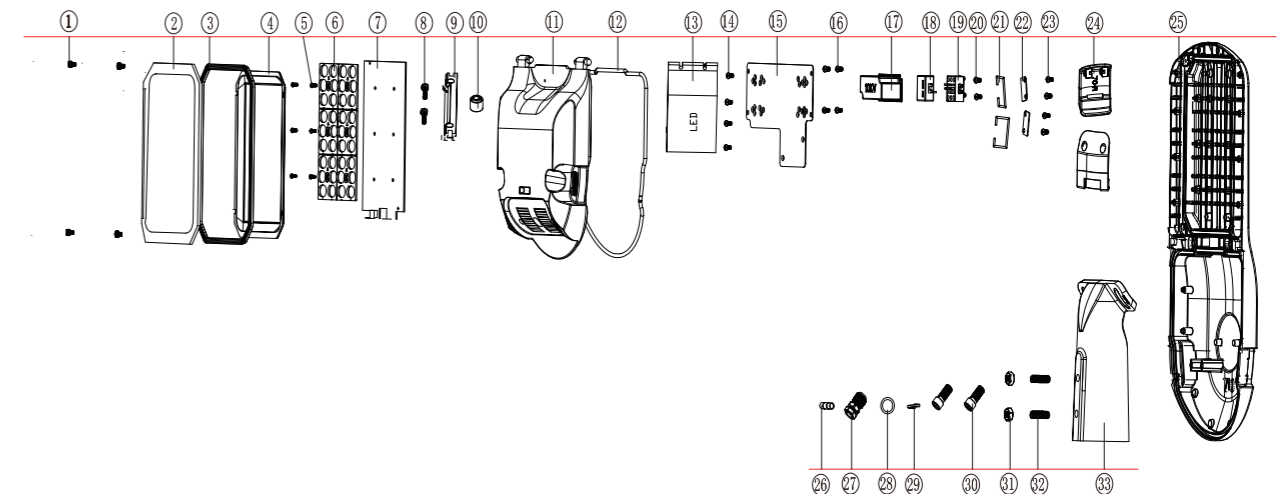

LED STREET LIGHT

LIGHT THE WORLD

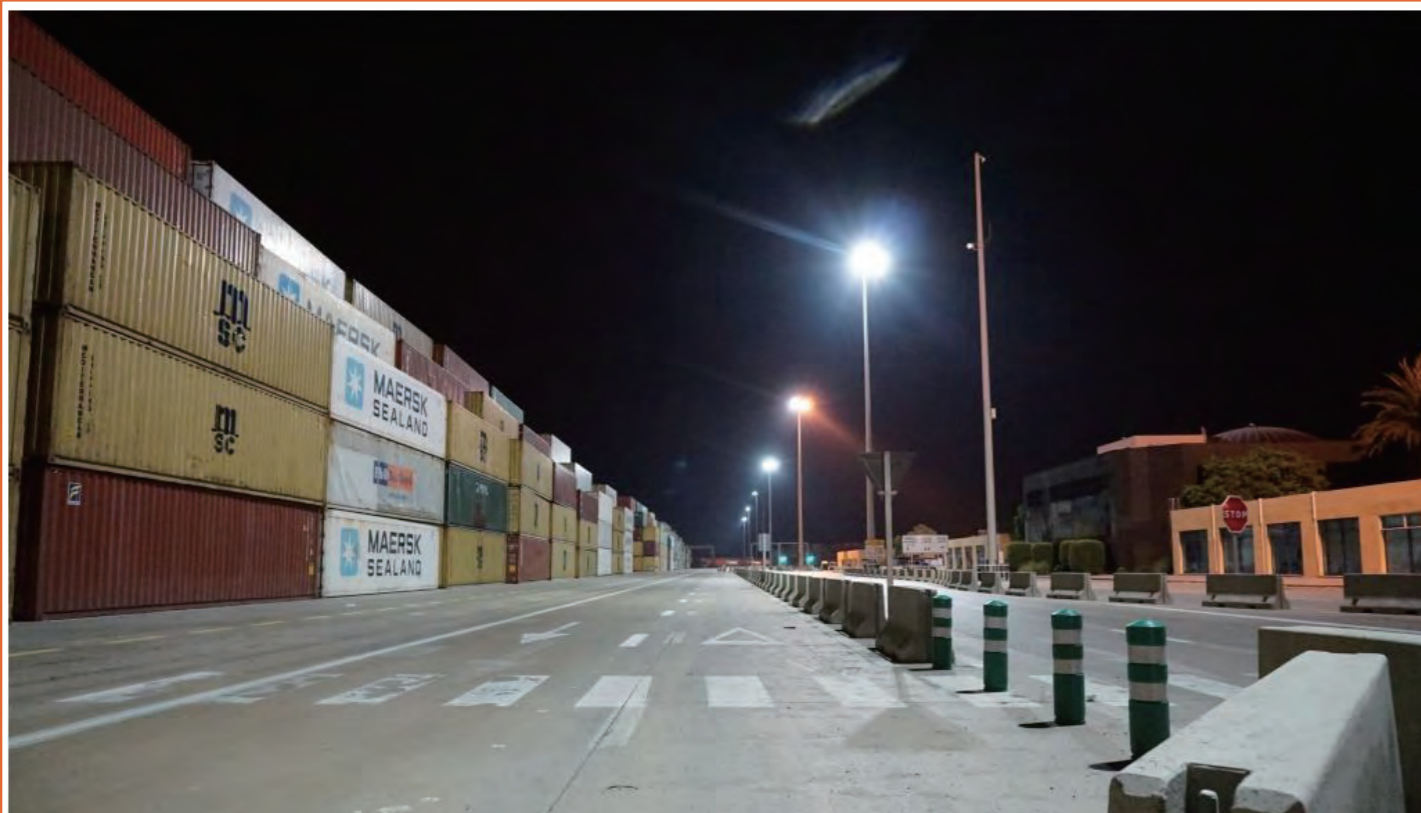

Certification: CE,ROHS,TUV,FCC,SAA,C-tick



ITEM No.	MSL-G240	MSL-G360	MSL-G480	MSL-G600	MSL-G720
Led Power	240W	360W	480W	600W	720W
Lumen Output	38400lm	57600lm	76800lm	96000lm	115200lm
NW/GW/CBM(kg)	5.5&6.2	6.9&7.9&8.5	9.5&10.5&11	10.8&12&14	13&14.5&16
Product size(mm)	W250*L332*L180	W480*L350*L180	W628*L350*H180	W776*L350*H180	W924*L350*H180
Carton size(mm)	370*360*230	500*370*230	640*370*230	780*370*230	920*370*230



Light Efficient	> 160lm/w	CRI	>80
Input Voltage	AC 85-305V	CCT	2700-6500k
Driver Brand	Meanwell driver	IP Grade	IP65
Led Lamp	PHILIPS SMD 5050	Power Factor	>0.95

LED STREET LIGHT

LIGHT THE WORLD

Lens optional

Symmetrical PC lens: 8°/20°/40°/60°/90°, Asymmetrical PC lens: 100°×140°

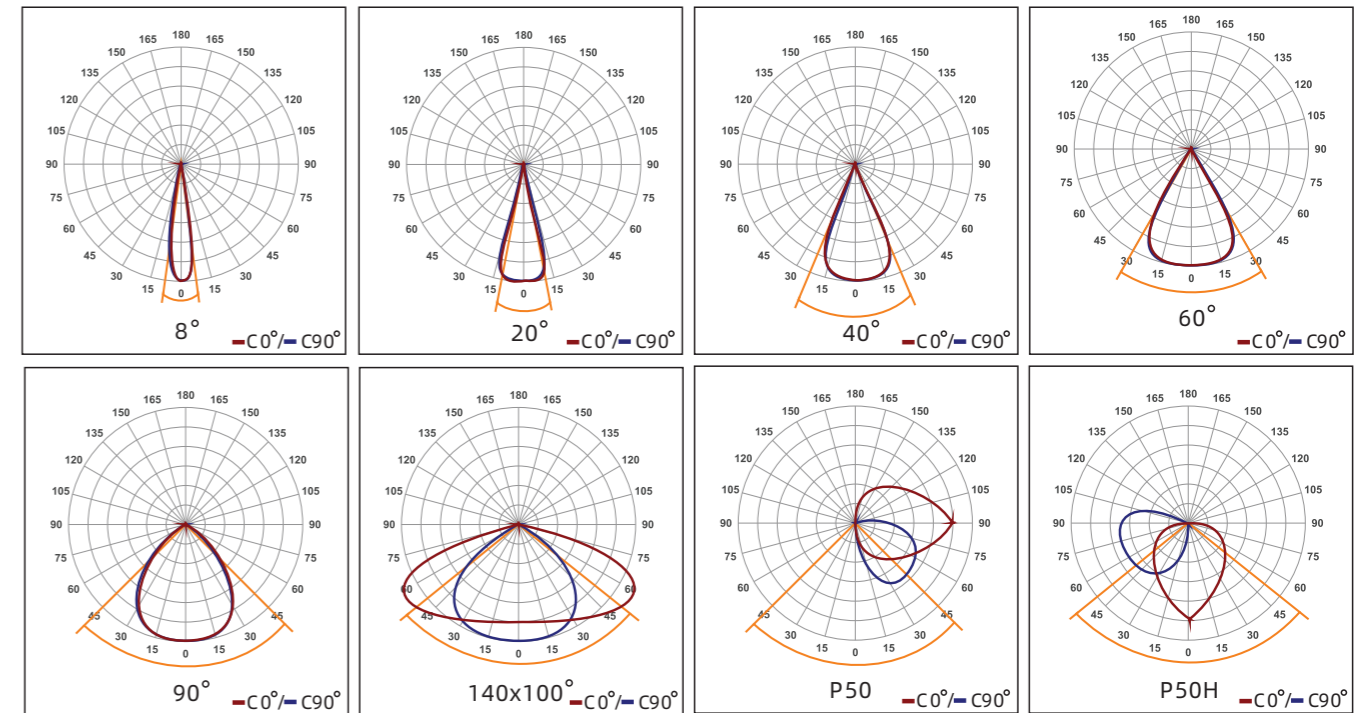

Advantage design of our Led flood light:

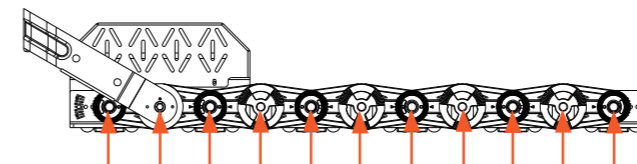

Where the Angle can be adjusted

1. MIC Folding heat sink used newest Stamping and twisting technology, Folding technology enlarge the dissipation area which make the heat fast to go out, which is 2 times much better than the diecasting aluminum or normal section bar heatsink in the market.
2. MIC folding heat sink used aviation aluminum -super thin which weight will be very light. For a same wattage light, our weight can 2 times less than compare normal design led light. So our lamp will be much more easy for installation, it will save your lamp pole's cost. And it will be more safe, it can stand strong hurricane.
3. MIC flood light's each single module's beam angle is adjustable, so user can adjust the angle easy without moving the bracket to get the best Uo, So when client install the lamp of us, they can easy to get Uo more than 0.9.
4. We had different installation adaptors optional, bracket use for flood light or slip fitter adaptor used for led street light.
5. Anti-glare mask can be installed.

LED STREET LIGHT

LIGHT THE WORLD



Certification: CE,ROHS,TUV,FCC,SAA,C-tick



ITEM No.	MSL-P30	MSL-P50	MSL-P80
Led Power	30W	50W	80W
Lumen Output	4200lm	7000lm	11200lm
NW/GW(kg)	2.9 & 4.3	2.9 & 4.3	3.9 & 6.8
Product size(mm)	425*200*121	425*200*121	540*256*125
Carton size(mm)	460*230*180	460*230*180	585*290*185

ITEM No.	MSL-P100	MSL-P120	MSL-P150
Led Power	100W	120W	150W
Lumen Output	14000lm	16800lm	21000lm
NW/GW(kg)	4.2 & 6.8	4.8 & 7.4	4.8 & 7.4
Product size(mm)	540*256*125	598.5*256*125	598.5*256*125
Carton size(mm)	585*290*185	645*290*185	645*290*185

LED STREET LIGHT

LIGHT THE WORLD



Light Efficient	> 160lm/w	CRI	>80
Input Voltage	AC 85-305V DC 12-24V	CCT	2700-6500k
Driver Brand	Meanwell & Sosen driver	IP Grade	IP66
Led Lamp	PHILIPS SMD 3030	Power Factor	>0.95

Photocell Sensor Optional

Automatically switches a light on at dusk and off at dawn.

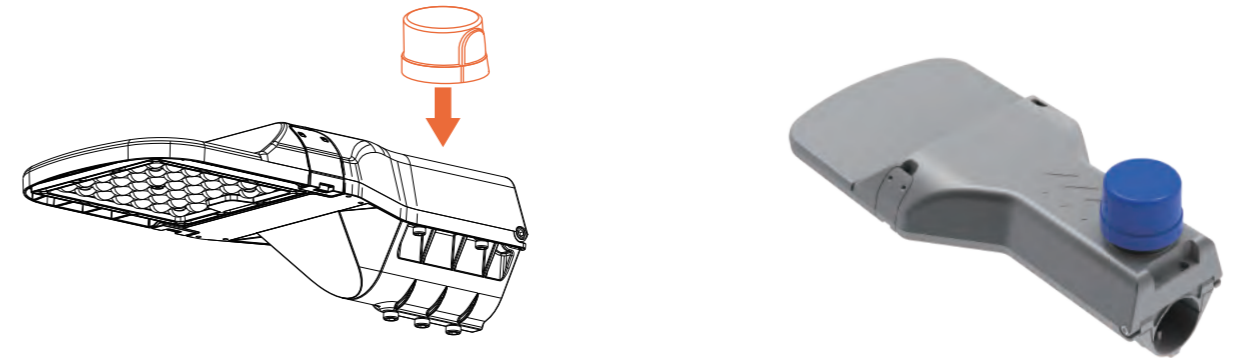

Spectrum

TYPE II

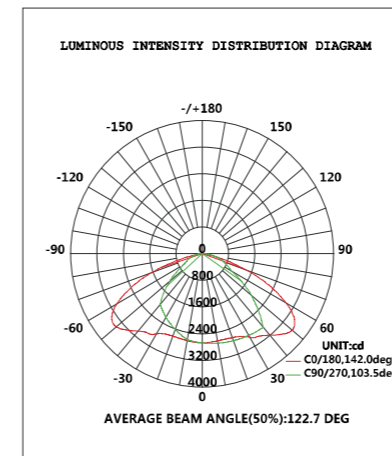

TYPE III

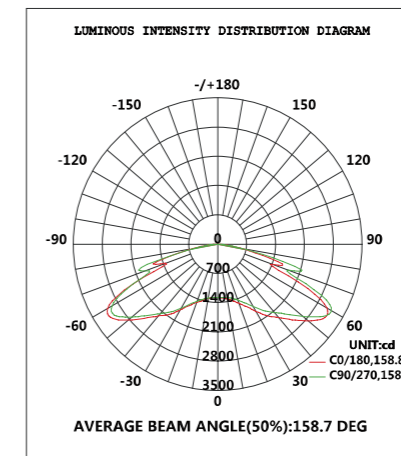

TYPE V

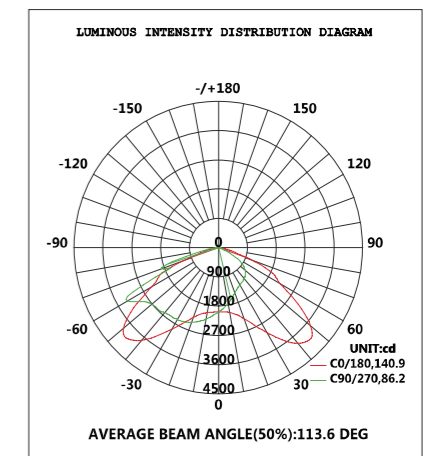

Application

LED Street Lighting series can be widely used in Urban roads, Industrial areas, Residential areas, Sidewalks, Parking lot, Schools, Gardens and etc.

LED SOLAR STREET LIGHT

LIGHT THE WORLD



Certification: CE,ROHS,ISO

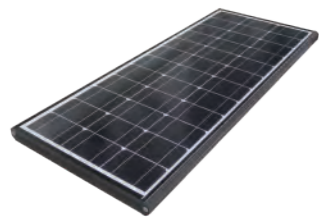

ITEM No.	MS-220	MS-230	MS-240	MS-260
Led Power / Battery	12V,20W / 10AH	12V,30W / 14AH	12V,40W / 16AH	12V,60W / 21AH
Solar panel power	18V / 25W	18V / 30W	18V / 35W	18V / 50W
Lumen Output	2600lm	3600lm	5200lm	7800lm
NW/GW	5.5kg/6.3kg	7.8kg/9.5kg	7.8kg/9.5kg	10.5kg/12kg
Product size(mm)	495*355*80	740*305*140	740*305*140	940*305*140
Carton size(mm)	570*390*150 1pcs/CTN	810*390*220, 1pcs/CTN	810*390*220, 1pcs/CTN	1000*390*220, 1pcs/CTN

ITEM No.	MS-280	MS-2100	MS-2120	MS-2150
Led Power / Battery	12V,80W / 26AH	12V,100W / 42AH	12V,120W / 60AH	12V,150W / 76AH
Solar panel power	18V / 65W	18V / 90W	18V / 130W	18V / 130W
Lumen Output	10400lm	13000lm	15600lm	19500lm
NW/GW	14.8kg/16.5kg	19kg/21kg	20kg/22kg	29kg/31kg
Product size(mm)	1120*305*140	1120*400*140	1120*440*140	1270*540*150
Carton size(mm)	1180*390*220 1pcs/CTN	1180*530*220 1pcs/CTN	1180*530*220 1pcs/CTN	1300*670*220 1pcs/CTN

LED SOLAR STREET LIGHT

LIGHT THE WORLD



Beam angle	75°*145°	CRI	>80
Solar panel	High efficiency monocrystalline solar cell	CCT	2700-6500k
Battery Type	Lithium battery	IP Grade	IP65
Led Lamp	PHILIPS SMD 3030	Warranty	3 years

Matters needing attention

Please choose a place that is full of sunlight and can be completely exposed to the sun. Notice that the solar panels must be covered, and must be exposed to the sun.



Pls don't install this product in shadow of trees or wall

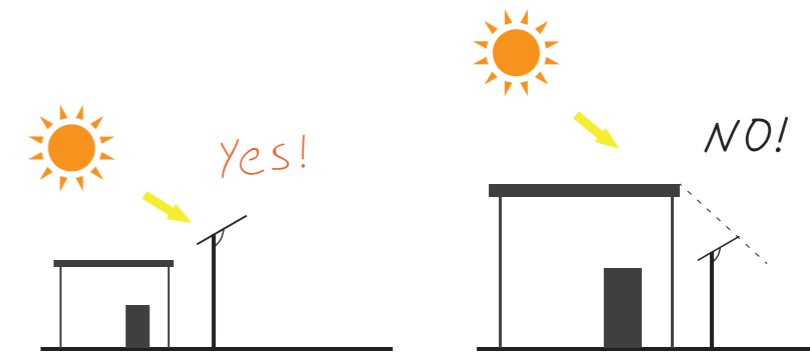

Matters needing attention

- "All-in-one" will not work without sun. Please select the matched product model according to the Sunlight intensity of the install location or the total annual radiation of solar energy. In the lacking sunlight or long continuous rainy day area, the working time of solar lights can be shortened or can not light, "All-in-one" light with mains supply or solar dual-mode electric power supply is suggested to choose in such case.
- "All-in-one" selects long-life lithium battery as energy storage device. Discharge condition at night is at temperature -30°C ~ +60°C, battery performance will be damaged beyond this range. Please make sure the local extreme temperature does not exceed the above condition when selecting the "All-in-one".
- "All-in-one" battery after fully charged, the longest store time can be up to six months. Check the battery in time after long time transport or storage, charge and record it on a regular time. Otherwise, the battery will be damaged.
- When installing "All-in-one", make the solar panel towards the direction of the sun as possible in order to get maximum energy and avoid houses and the shadow of obstacles such as trees at the same time, otherwise it will reduce the generating efficiency of the solar panel, and lead to "All-in-one" working time being shortened.
- "All-in-one" solar panel surface's degree of cleanliness also affects the generating efficiency of the solar panel. So its surface (such as dust, leaves, greasy dirt, etc.) needs to be cleaned, scrubbing with ordinary cleaner on a regular time is suggested.
- "All-in-one" internal parts are with good waterproof design, all reach IP65 standard. Ventilation holes and cracks on the shell are specially designed for the cooling and drainage. Metal parts are all made of corrosion resistance 1060 aviation aluminum or stainless steel, which can tolerate the strict environment of the sea or high heat and high humidity desert.

SEMI-SEPARATED SOLAR STREET LIGHT

LIGHT THE WORLD



Certification: CE, ROHS, ISO



ITEM No.	MIC-G03-20W	MIC-G03-30W	MIC-G03-40W	MIC-G03-50W	MIC-G03-60W
Led Power / Battery	20W / 159.8WH	30W / 213.1WH	40W / 239.8WH	50W / 319.6WH	60W / 319.6WH
Solar panel power	18V, 35W	18V, 50W	18V, 50W	18V, 60W	18V, 60W
Lumen Output	2600-3000lm	3900-4500lm	5200-6000lm	6500-7500lm	7800-9000lm
NW/GW	13.3kg/15.8kg	14.7kg/17.4kg	14.9kg/17.6kg	15.9kg/18.8kg	15.9kg/18.8kg
Product size(mm)	600*240*230	650*240*230	650*240*230	650*240*230	650*240*230
Solar panel size(mm)	430*513*30	625*513*30	625*513*30	780*513*30	780*513*30



LED bead	160lm/W	CRI	>70
Solar panel	High efficiency monocrystalline solar cell	CCT	2700-6500k
Battery Type	Lithium battery	IP Grade	IP65
Led Lamp	PHILIPS SMD 3030	Warranty	3 years

SEMI-SEPARATED SOLAR STREET LIGHT

LIGHT THE WORLD

Function characteristics

1). Solar panel could be rotated 360° horizontally and 240° vertically, which will increase the photoelectronical conversion maximum in different areas; customized solar panel is available.

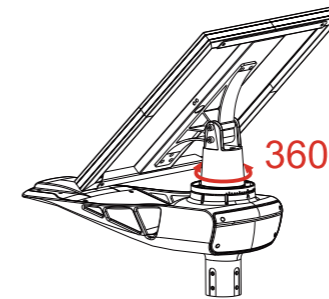

Rotated 360° horizontally

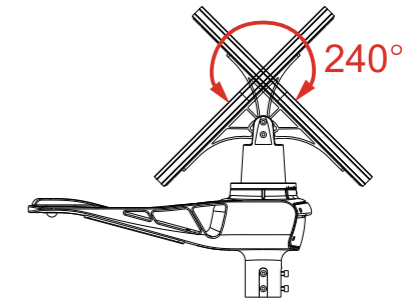

Rotated 240° vertically

Microwave/PIR sensor

Use advanced Microwave/PIR Sensor technology, more sensitive and optimize brightness automatically. Max sensing distance is 12M. The build-in Microwave/PIR Sensor could automatically regulate brightness by identify moving object around, increase brightness when object approaches and decrease after object leaves about 20-30s (can be customized). This fluctuation of lighting intensity could preserves solar energy effectively.

No object

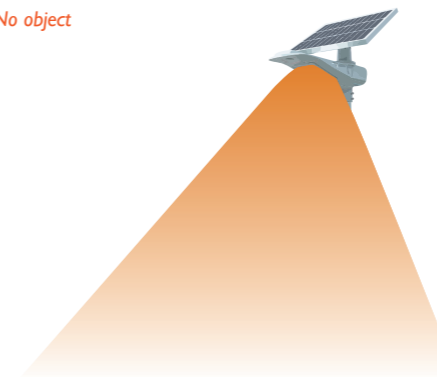

With object

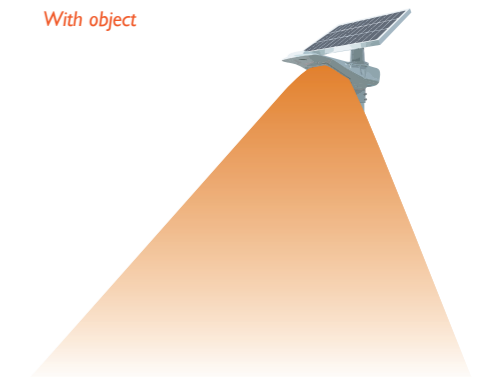

Mobile APP

The Mobile App in smartphone could be used to easily monitor and remotely control the light via the Bluetooth connection.

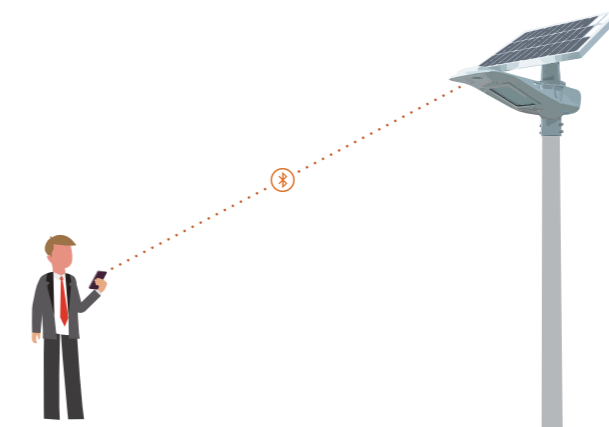

SOLAR LED FLOOD LIGHT

LIGHT THE WORLD



Certification: CE,ROHS,TUV,FCC,DLC/ETL,SA,A,C-tick



ITEM No.	MFL-10S	MFL-20S	MFL-25S
Led Power	10W	20W	25W
Solar panel	Polysilicon solar cell 6v 10w	Polysilicon solar cell 6v 10w	Polysilicon solar cell 6v 12w
Battery	3.2V / 6AH lithium battery	3.2V / 8AH lithium battery	3.2V / 8AH lithium battery
Product size	350*235*17mm	350*235*17mm	350*235*17mm
Carton size	520*300*380mm, 10pcs/CTN, 22kg	520*300*380mm, 10pcs/CTN, 24kg	490*290*380mm, 10pcs/CTN, 22kg

ITEM No.	MFL-40S	MFL-60S	MFL-100S
Led Power	40W	60W	100W
Solar panel	Polysilicon solar cell 6v 18w	Polysilicon solar cell 6v 22w	Polysilicon solar cell 6v 35w
Battery	3.2V / 12AH lithium battery	3.2V / 15AH lithium battery	3.2V / 15AH lithium battery
Product size	400*370*17mm	460*350*17mm	530*530*17mm
Carton size	530*410*440mm, 10pcs/CTN, 34kg	460*370*500mm, 8pcs/CTN, 33kg	640*440*390mm, 6pcs/CTN, 33kg

SOLAR LED FLOOD LIGHT

LIGHT THE WORLD

Polycrystalline Solar Panels

Made of polysilicon panels, it has a higher Photoelectric Conversion Rate—18%, it can also be charged in rainy weather, faster charge particular in a sunny day. only 4-6 hours can it make a full charge.

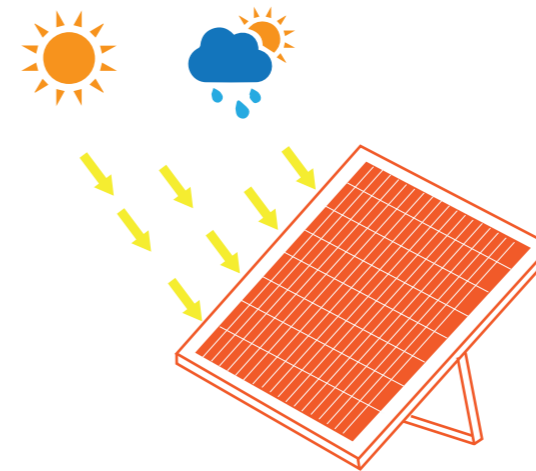

Long-Lasting Light

The battery is large capacity, stable and more durable, with overcharge and overdischarge protection.

Battery lifespan comparison chart

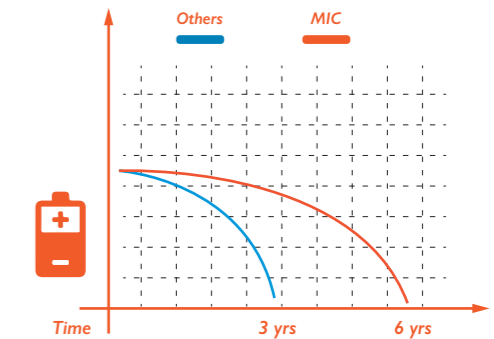

Lithium battery cycle life > 2000 (0.2C rate, IES Standard)

Matters needing attention

Please choose a place that is full of sunlight and can be completely exposed to the sun. Notice that the solar panels must be covered, and must be exposed to the sun.

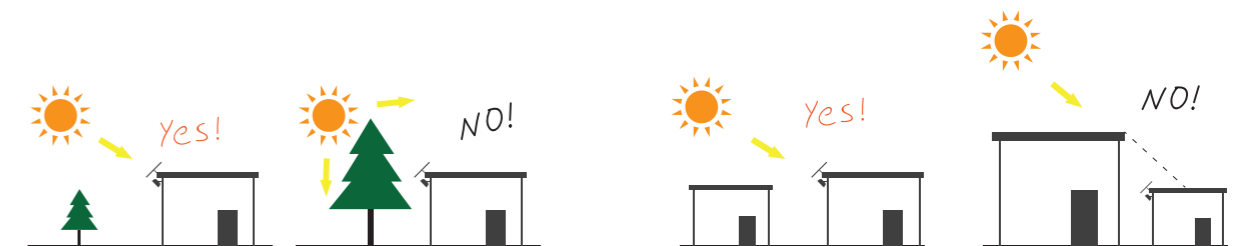

Pls don't install this product in shadow of trees or wall

Matters needing attention

- Solar led flood light will not work without sun. Please select the matched product model according to the Sunlight intensity of the install location or the total annual radiation of solar energy. In the lacking sunlight or long continuous rainy day area, the working time of solar lights can be shortened or can not light.
- Solar led flood light selects long-life lithium battery as energy storage device. Discharge condition at night is at temperature - 30°C ~ + 60°C, battery performance will be damaged beyond this range. Please make sure the local extreme temperature does not exceed the above condition when selecting the Solar led flood light.
- Solar led flood light battery after fully charged, the longest store time can be up to six months. Check the battery in time after long time transport or storage, charge and record it on a regular time. Otherwise, the battery will be damaged.
- When installing Solar led flood light, make the solar panel towards the direction of the sun as possible in order to get maximum energy and avoid houses and the shadow of obstacles such as trees at the same time, otherwise it will reduce the generating efficiency of the solar panel, and lead to solar led flood light's working time being shortened.
- Solar led flood light's solar panel surface's degree of cleanliness also affects the generating efficiency of the solar panel. So its surface (such as dust, leaves, greasy dirt, etc.) needs to be cleaned, scrubbing with ordinary cleaner on a regular time is suggested.
- Solar led flood light internal parts are with good waterproof design, all reach IP65 standard. Ventilation holes and cracks on the shell are specially designed for the cooling and drainage. Metal parts are all made of corrosion resistance aluminum or stainless steel, which can tolerate the strict environment of the sea or high heat and high humidity desert.

LED YARD LIGHT

LIGHT THE WORLD



Certification: CE,ROHS,TUV,FCC,SAA,C-tick



ITEM No.	ST04-XX01	ST05-XX01
Led Power	35W	50W
Lumen Output	4550lm	6500lm
Weight	1.9kg	1.95kg
Product size(mm)	285*195*100	285*195*100
Carton size(mm)	410*310*350, 6pcs/CTN 430*260*145, 1pcs/CTN	410*310*350, 6pcs/CTN 430*260*145, 1pcs/CTN



Beam angle	120°	CRI	>80
Input Voltage	AC 85-300V & 347V	CCT	2700-6500k
Driver Brand	CE/Meanwell UL driver	IP Grade	IP65
Led Lamp	PHILIPS SMD 5050	Power Factor	>0.95

LED YARD LIGHT

LIGHT THE WORLD

Photocell sensor (optional)

Photo electric switch for outdoor use Lighting from early evening & Dark when dawn.



Photocell Sensor A



Photocell Sensor B

Installation Instruction

1. Dusk-to-dawn LED Outdoor Barn Light luminaire features a design that can be mounted to any vertical surface using lag bolts or other comparable and suitable anchors, with a wiring compartment that is easily accessible without the need to remove the lens or disassemble the fixture.
2. Dusk-to-dawn LED Outdoor Barn Light can also be mounted to existing 1-1/2" or 1-5/8" pipe mounts, offering the installer the flexibility to satisfy many different mounting applications and requirements.
3. This is especially useful when using the LED Outdoor Barn Light to retrofit older dusk-to dawn luminaires.

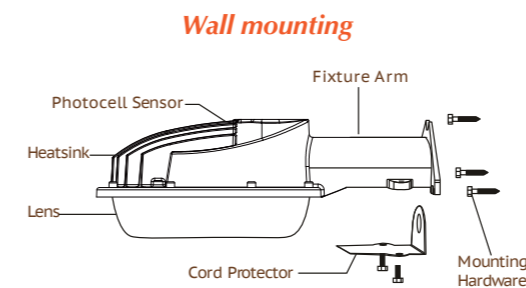

Qty: 6 P C S

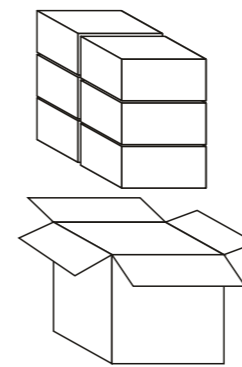

Inner Box: 300*200*110mm
Outer Carton: 410*310*350mm

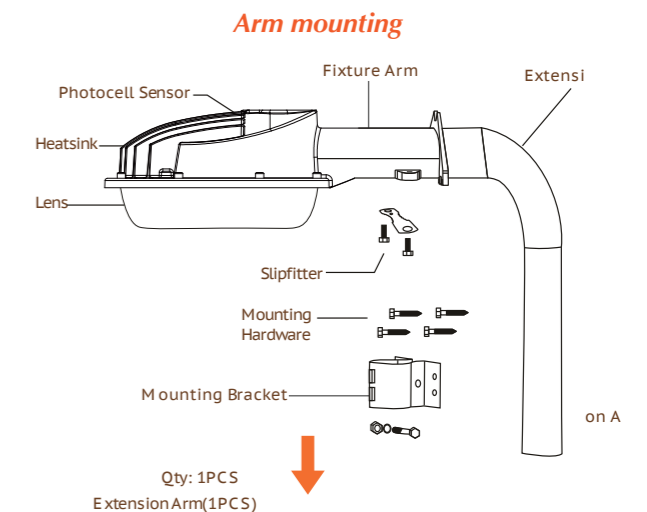

Qty: 1PCS
Extension Arm(1PCS)

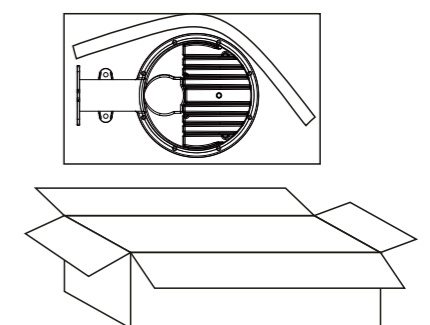

Outer Carton: 425*250*130mm

LED CANOPY LIGHT

LIGHT THE WORLD



Certification: CE,ROHS,TUV,FCC,SAA,C-tick



ITEM No.	CP01-XX01	CP01-XX02	CP01-XX03
Led Power	40W	60W	80W
Lumen Output	4400lm	6600lm	8800lm
NW/GW	2.3kg/2.6kg	2.3kg/2.6kg	2.4kg/2.7kg
Product size(mm)	265*265*85	265*265*85	265*265*85
Carton size(mm)	470*285*310, 4pcs/CTN	470*285*310, 4pcs/CTN	470*285*310, 4pcs/CTN

ITEM No.	CP01-XX04	CP01-XX05	CP03-XX01
Led Power	100W	120W	150W
Lumen Output	11000lm	13200lm	16500lm
NW/GW	3.6kg/3.9kg	3.7kg/4kg	6kg/6.7kg
Product size(mm)	314*314*95	314*314*95	380*380*70
Carton size(mm)	520*335*310, 4pcs/CTN	520*335*310, 4pcs/CTN	450*450*150, 1pcs/CTN

LED CANOPY LIGHT

LIGHT THE WORLD



Beam angle	120°	CRI	>80
Input Voltage	AC 100-277V	CCT	2700-6500k
Driver Brand	CE/Meanwell UL driver	IP Grade	IP65
Led Lamp	PHILIPS SMD 3030	Power Factor	>0.95

Bracket Mounting

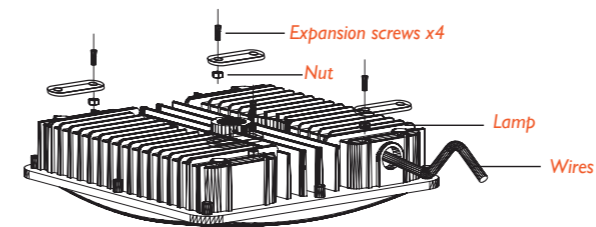

Hook Mounting

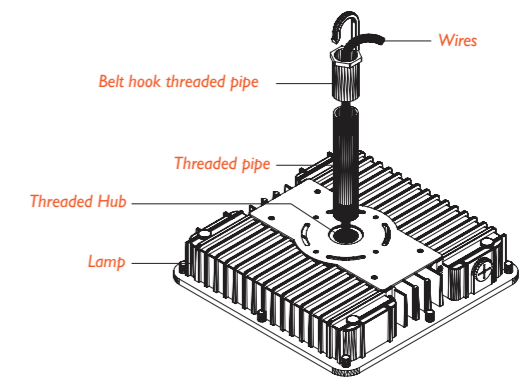

Auto dealership, corporate & office, education, government, healthcare industrial & warehouse, municipal, parking, petroleum & convenience stores, recreation & public venues, restaurants & hospitality, retail & grocery.

Installation Instruction

- * Warning: cut off electrical source in order to avoid electrical shock and endanger life-safety before installation.
 - * Installation height at 1.2m or more that it.
- ELECTRICAL CONNECTIONS-100-240V/277V AC, 50/60HZ
PHASE TO NEUTRAL WIRING

Features

1. Universal voltage AC100-277V 50 60Hz.
2. 110lm/W for fixture.
3. Using high quality 3030 chips, LM-80 report and IES data available.
4. Mean Well UL/cUL driver.
5. High Power Factor >0.9, Low THD Driver.
6. Brown die-casting aluminum case, PC cover.
7. The lamp with the powder coating is brighter, without fading and corrosion.
8. Built-in light module, easy maintenance, low maintenance costs.
9. 5 years Warranty.
10. UL/DLC/Lighting facts certificate.

LED WALL PACK LIGHT

LIGHT THE WORLD



Certification: CE,ROHS,TUV,FCC,SAA,C-tick



ITEM No.	MWP-40	MWP-60	MWP-100
Led Power	40W	60W	100W
Lumen Output	5200lm	7800lm	13000lm
Weight	3.3kg	3.8kg	4kg
Product size(mm)	320*132*115	320*132*115	320*132*115
Carton size(mm)	370*210*180, 1pcs/CTN	370*210*180, 1pcs/CTN	370*210*180, 1pcs/CTN



Beam angle	100*100°	CRI	>80
Input Voltage	AC 90-277V	CCT	2700-6500k
Driver Brand	CE/Meanwell UL driver	IP Grade	IP65
Led Lamp	PHILIPS SMD 3030	Power Factor	>0.95

LED WALL PACK LIGHT

LIGHT THE WORLD

Installation

1. cut off power supply before using, can used in voltage AC90-277V(50-60Hz)
2. The light should be avoided installed heat source place and superheated steam, corrosive gas place.
3. Ensure install place can bear 10 times of the light weight before installation. Installed at no shake, no high - hazard contents, and flat place Avoid falling, crash...
4. The products are waterproof P65, can use outdoor for long time.

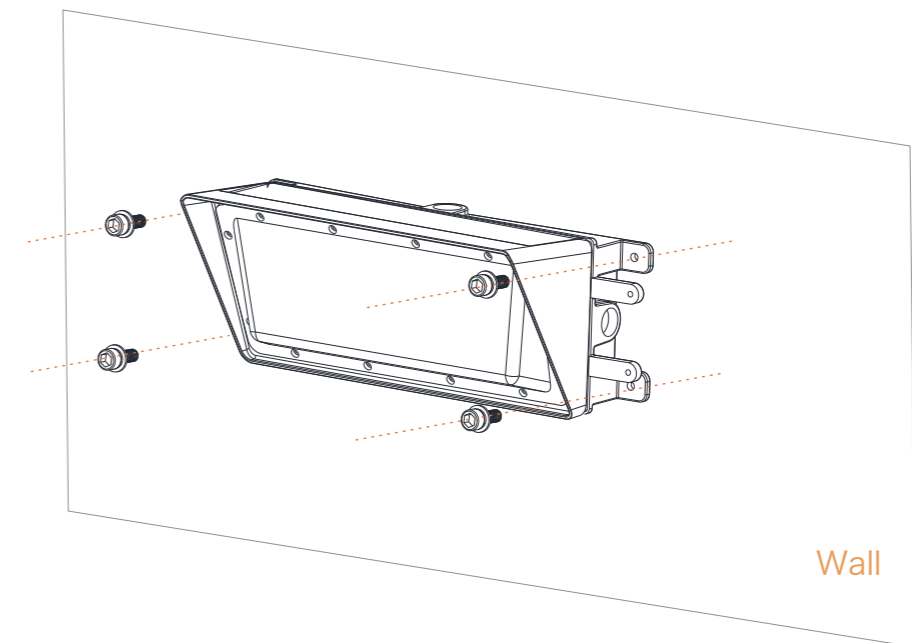

Product features

1. Internal with heatsink+ shading roof design
2. Philips 3030 leds,Ultra-Bright, finished lamps over 130lm/W.
3. DLC 4.3 light distribution design
4. Streamline design with small size, save shipping cost
5. IP65 waterproof class, widely used in building facades,parking lots,garages,sidewalks,loading areas and other outdoor places

LED GARDEN LIGHT

LIGHT THE WORLD



Certification: CE,ROHS,TUV,FCC,SAA,C-tick



ITEM No.	MYL-A75	MYL-A100	MYL-A120
Led Power	75W	100W	120W
Lumen Output	9750lm	13000lm	15600lm
NW/GW(kg)	7.5&9	7.5&9	7.5&9
Product size(mm)	W452*L452*H551	W452*L452*H551	W452*L452*H551
Carton size(mm)	540*540*650	540*540*650	540*540*650

Light Efficient	> 130lm/w	CRI	>80
Input Voltage	AC 85-305V	CCT	2700-6500k
Driver Brand	Meanwell driver	IP Grade	IP66
Led Lamp	PHILIPS SMD 3030	Power Factor	>0.95

LED GARDEN LIGHT

LIGHT THE WORLD

Installation



UP & DOWN installation

The MIC fastening system can be installed in UP configuration (head pole or bracket in ported configuration) DOWN (suspension on arms or on rope stretched). The UP version is available with both two and four arms, the DOWN one it is standard with four arms. The version UP four arms can take on a shape more classic if corrected of the dedicated hat.



UP & DOWN installation

The MIC fastening system can be installed in a flush-mounted configuration (most head or cantilever in load-bearing configuration) or in DOWN configuration (suspension on cantilevers or on a tensioned wire rope). The UP version is available with both two and four arms, while the DOWN version has four arms as standard. The flush-mounted version with four arms can take on a more classic shape if it is equipped with a specific decorative cover.

Feature

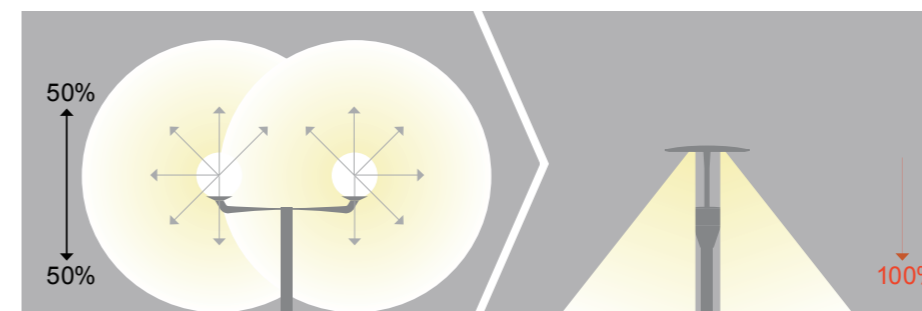

Energy Saving	75%
Light Pollution	0%
Life time	>50.000 hrs
On-off	immediately
Warranty	5 years

Impatto ambientale ridotto

La sostituzione di vecchi punti luce a lampada con i prodotti della linea MIC consente un elevato risparmio energetico e una riduzione dell'inquinamento luminoso. (Cut -Off)

Reduced environmental impact

The replacement of old light points lamp with the products of the MIC line allows high energy savings and a reduction in pollution bright. (Cut -Off)

Reduzierte Umweltbelastung

Die Auswechslung alter Glühbirnen-Lichtpunkte mit den Produkten der MIC-Produktreihe ermöglicht eine hohe Energieeinsparung und eine Verringerung der Lichtverschmutzung. (Cut -Off)

LED GARDEN LIGHT

LIGHT THE WORLD

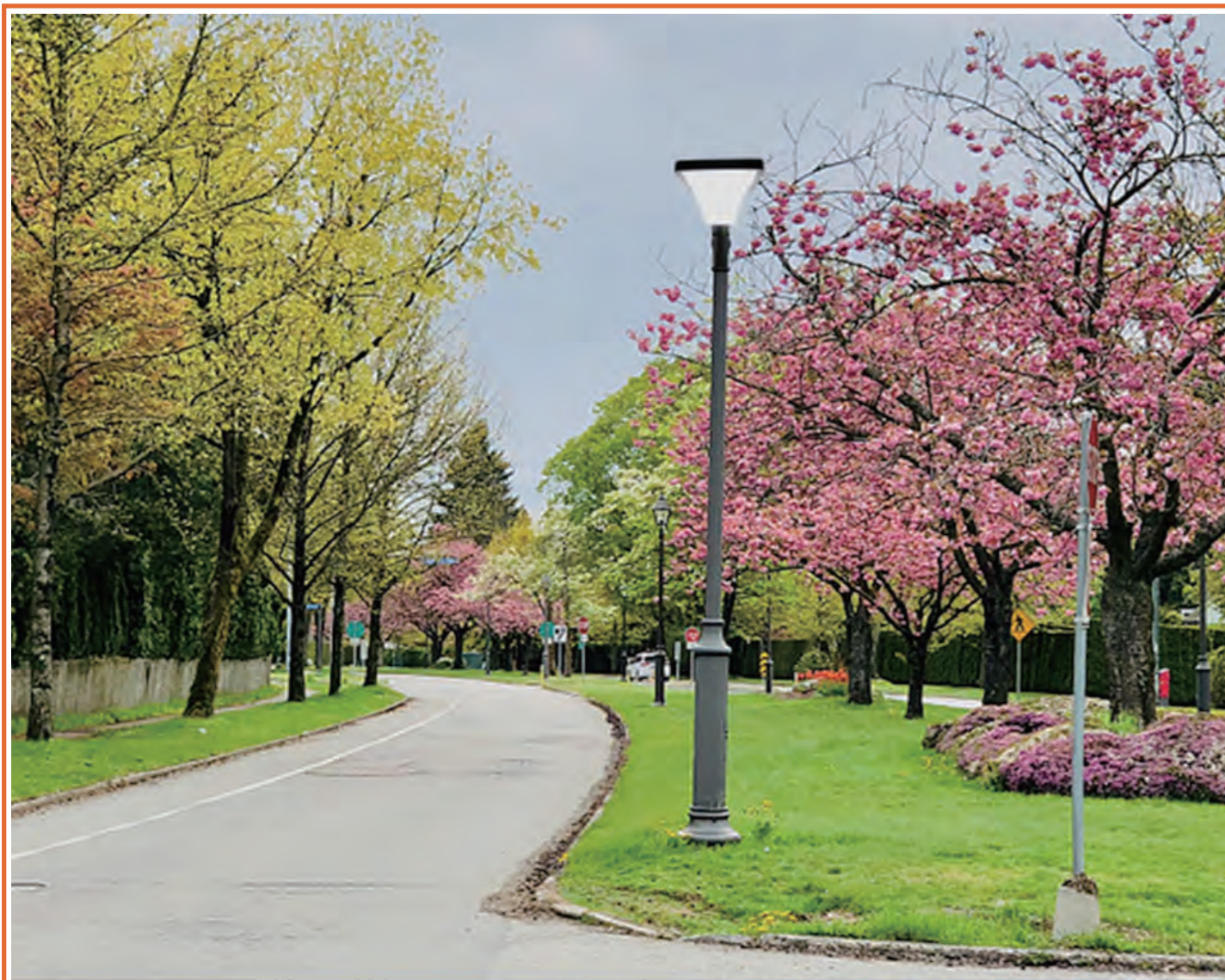

Certification: CE,ROHS,TUV,FCC,SAA,C-tick

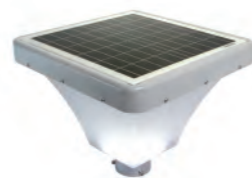

LED GARDEN LIGHT

LIGHT THE WORLD

Microwave/PIR sensor

Use advanced Microwave/PIR Sensor technology, more sensitive and optimize brightness automatically. Max sensing distance is 12M. The build-in Microwave/PIR Sensor could automatically regulate brightness by identify moving object around, increase brightness when object approaches and decrease after object leaves about 20-30s (can be customized). This fluctuation of lighting intensity could preserves solar energy effectively.

No object

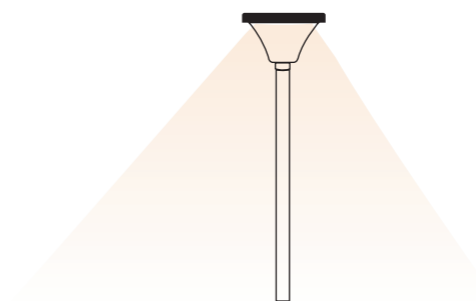

With object

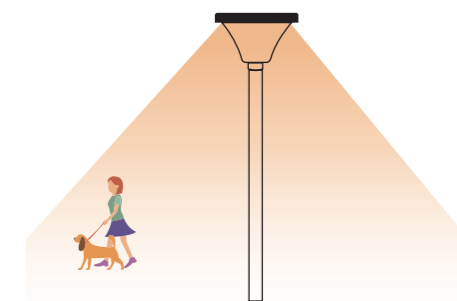

Matters needing attention

Please choose a place that is full of sunlight and can be completely exposed to the sun. Notice that the solar panels must be covered, and must be exposed to the sun.



Pls don't install this product in shadow of trees or wall

1. "All-in-one" will not work without sun. Please select the matched product model according to the Sunlight intensity of the install location or the total annual radiation of solar energy. In the lacking sunlight or long continuous rainy day area, the working time of solar lights can be shortened or can not light, "All-in-one" light with mains supply or solar dual-mode electric power supply is suggested to choose in such case.
2. "All-in-one" selects long-life lithium battery as energy storage device. Discharge condition at night is at temperature -30 C ~ +60 C, battery performance will be damaged beyond this range. Please make sure the local extreme temperature does not exceed the above condition when selecting the "All-in-one".
3. "All-in-one" battery after fully charged, the longest store time can be up to six months. Check the battery in time after long time transport or storage, charge and record it on a regular time. Otherwise, the battery will be damaged.
4. When installing "All-in-one", make the solar panel towards the direction of the sun as possible in order to get maximum energy and avoid houses and the shadow of obstacles such as trees at the same time, otherwise it will reduce the generating efficiency of the solar panel, and lead to "All-in-one" working time being shortened.
5. "All-in-one" solar panel surface's degree of cleanliness also affects the generating efficiency of the solar panel. So its surface (such as dust, leaves, greasy dirt, etc.) needs to be cleaned, scrubbing with ordinary cleaner on a regular time is suggested.
6. "All-in-one" internal parts are with good waterproof design, all reach IP65 standard. Ventilation holes and cracks on the shell are specially designed for the cooling and drainage. Metal parts are all made of corrosion resistance 1060 aviation aluminum or stainless steel, which can tolerate the strict environment of the sea or high heat and high humidity desert.



Light Efficient	> 140lm/w	CRI	>80
Input Voltage	AC 85-305V DC 12-24V	CCT	2700-6500k
Driver Brand	Meanwell driver	IP Grade	IP66
Led Lamp	PHILIPS SMD 3030 & 5050	Power Factor	>0.95

LED GARDEN LIGHT

LIGHT THE WORLD



Certification: CE,ROHS,TUV,FCC,SAA,C-tick



ITEM No.	MYL-A50-I	MYL-A75-I	MYL-A100-I	MYL-A120-I
Led Power	50W	75W	100W	120W
Lumen Output	6500lm	9750lm	13000lm	15600lm
NW	8kg	8.3kg	8.5kg	8.5kg
Product size(mm)	Dia600*H337	Dia600*H337	Dia600*H337	Dia600*H337
Carton size(mm)	660x660x520	660x660x520	660x660x520	660x660x520



Beam angle	120°	CRI	>80
Input Voltage	AC 85-305V	CCT	2700-6500k
Driver Brand	CE / Meanwell / Sosen driver	IP Grade	IP66
Led Lamp	Philips 3030 Led	Power Factor	>0.95

LED GARDEN LIGHT

LIGHT THE WORLD

Installation

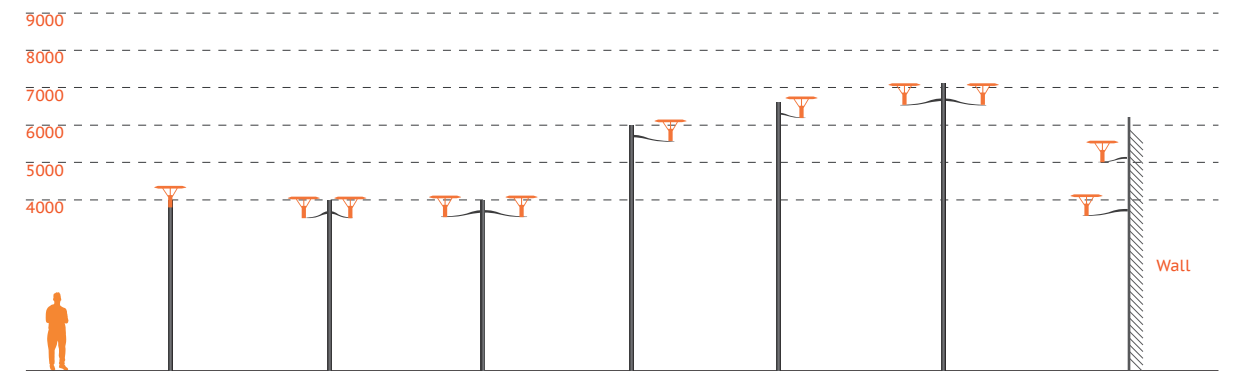

Lighting characteristics

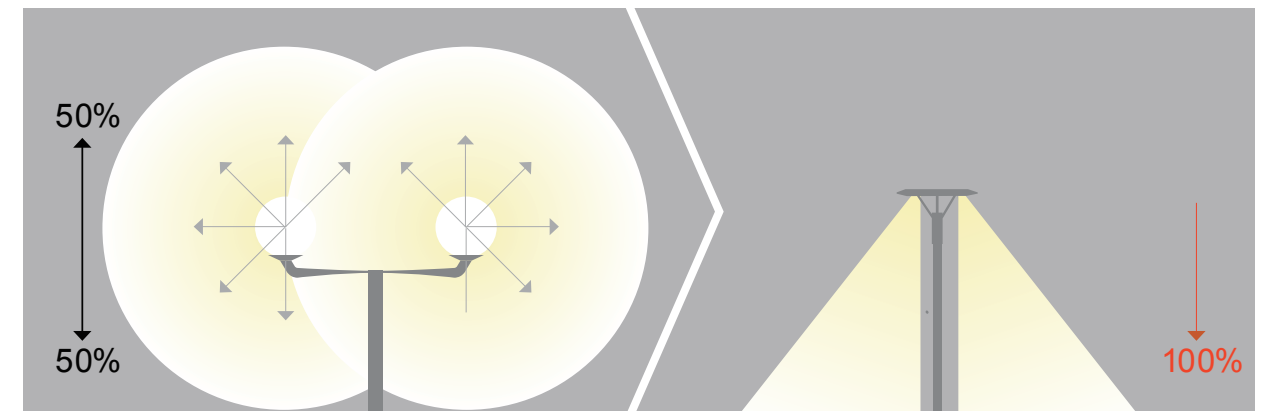

Energy Saving	75%
Light Pollution	0%
Life time	>50.000 h
On-off	immediately
Warranty	5 years

Impatto ambientale ridotto

La sostituzione di vecchi punti luce a lampada con i prodotti della linea MIC consente un elevato risparmio energetico e una riduzione dell'inquinamento luminoso. (Cut -Off)

Reduced environmental impact

The replacement of old light points lamp with the products of the MIC line allows high energy savings and a reduction in pollution bright. (Cut -Off)

LED GARDEN LIGHT

LIGHT THE WORLD



Certification: CE,ROHS,TUV,FCC,SAA,C-tick



ITEM No.	MYL-A50-2	MYL-A75-2	MYL-A100-2	MYL-A120-2
Led Power	50W	75W	100W	120W
Lumen Output	6500lm	9750lm	13000lm	15600lm
NW	7.1kg	7.3kg	7.3kg	7.5kg
Product size(mm)	400*400*695	400*400*695	400*400*695	400*400*695
Carton size(mm)	450*450*760	450*450*760	450*450*760	450*450*760



Beam angle	120°	CRI	>80
Input Voltage	AC 90-305V	CCT	2700-6500k
Driver Brand	CE / Meanwell / Sosen driver	IP Grade	IP66
Led Lamp	Philips 3030 Led	Power Factor	>0.95

LED GARDEN LIGHT

LIGHT THE WORLD

Installation

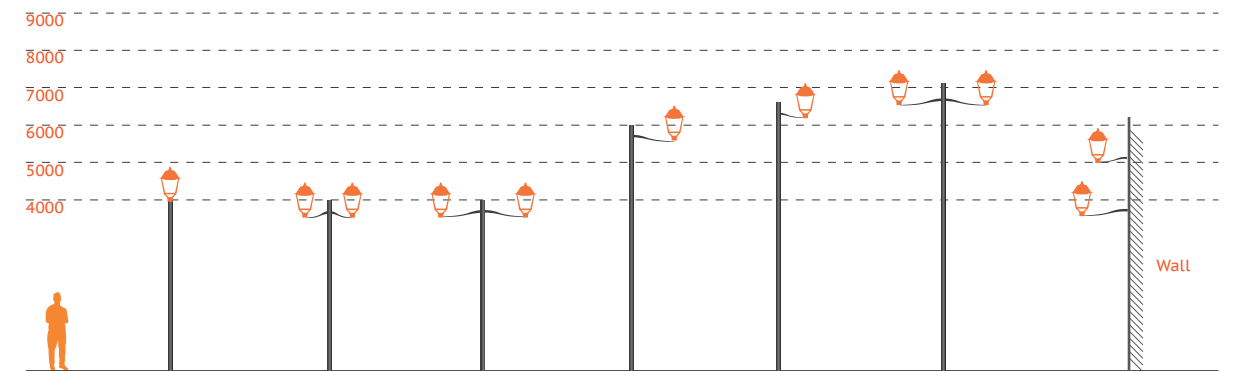

Lighting characteristics

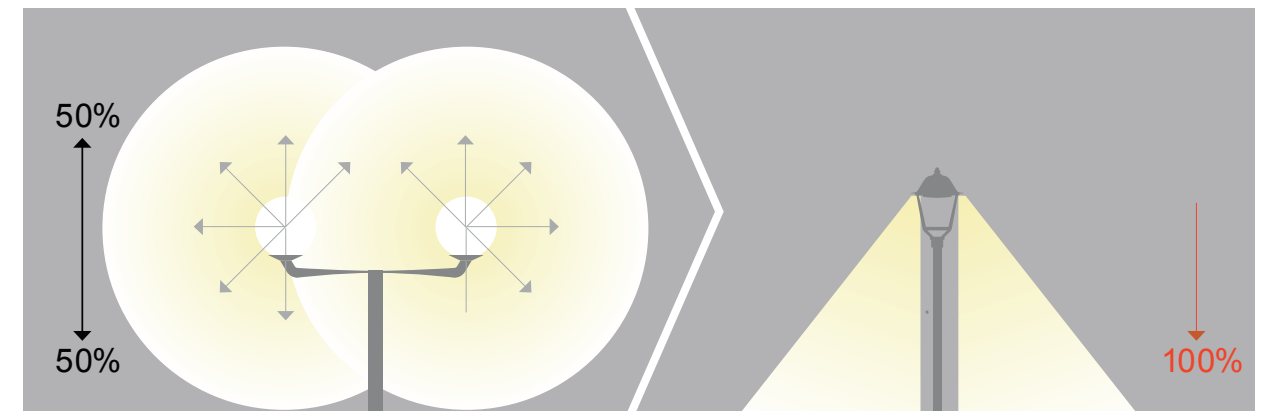

Energy Saving	75%
Light Pollution	0%
Life time	>50.000 h
On-off	immediately
Warranty	5 years

Impatto ambientale ridotto

La sostituzione di vecchi punti luce a lampada con i prodotti della linea MIC consente un elevato risparmio energetico e una riduzione dell'inquinamento luminoso. (Cut -Off)

Reduced environmental impact

The replacement of old light points lamp with the products of the MIC line allows high energy savings and a reduction in pollution bright. (Cut -Off)

LED WALL LIGHT

LIGHT THE WORLD

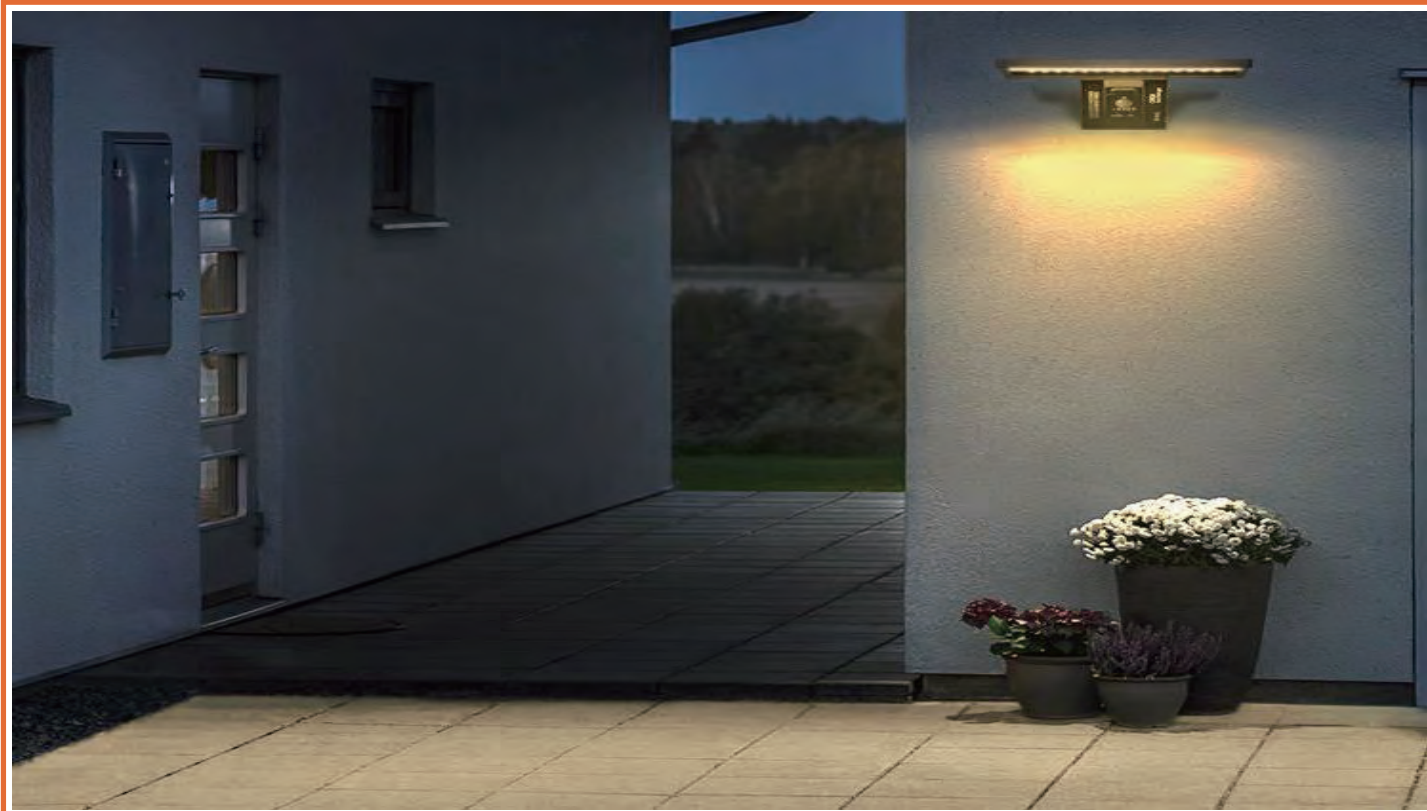

Certification: CE,ROHS,TUV,FCC,SAA,C-tick

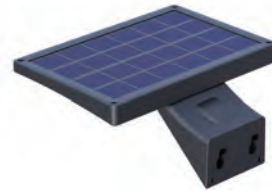

ITEM No.	MWP-S3	MWP-S5	MWP-S8
Led Power	3W	5W	8W
Lumen Output	360lm	600lm	600lm
NW	0.4kg	0.6kg	0.7kg
Product size(mm)	213*98*102	207*183*98	240*215*98
Carton size(mm)	230*110*70	210*210*70	240*240*70



Beam angle	Type II	CRI	>80
Li-ion Battery	18650 3.7V Li-ion Battery	CCT	2700-6500k
Solar panel	Mono-Crystalline Silicon	IP Grade	IP66
Led Lamp	Philips 3030 Led	Power Factor	>0.95

LED WALL LIGHT

LIGHT THE WORLD

Working Modes

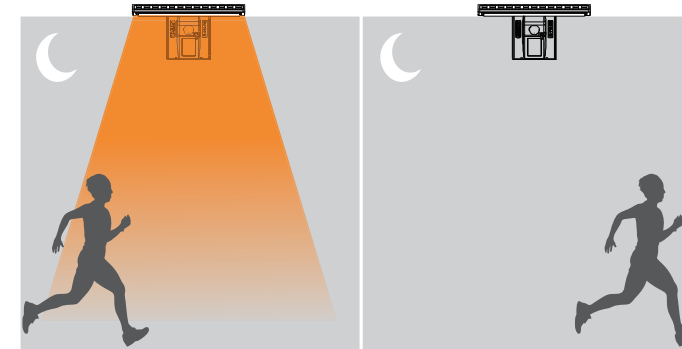

MODE 1

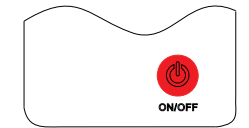

Press switch button LED Light flashes 2 times

Lamp would keep switch off in daylight or when no people passed by at night, When people passed by at night, lamp would switch to full brightness until people walked out of the PIR sensor detection range, lamp full brightness last 20s, then switch off automatically

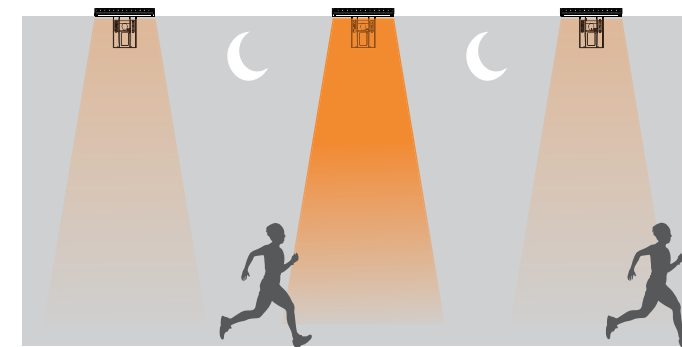

MODE 2

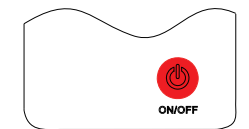

Press switch button LED Light flashes 2 times

Lamp switch off in daylight. Always keep weak brightness when no people passed by at night. When people passed by at night, lamp switch to full brightness until people walked out of the PIR sensor detection range, lamp full brightness last 20s, then switch to weak brightness automatically

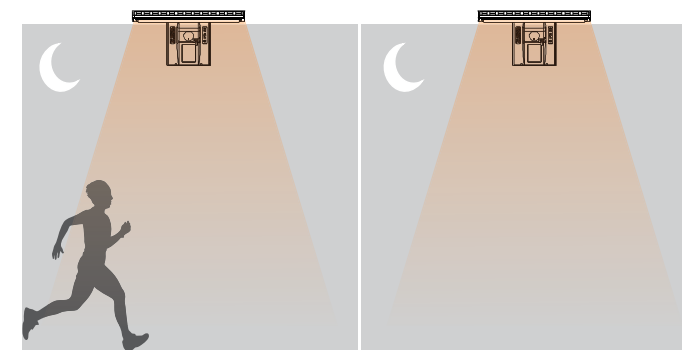

MODE 3

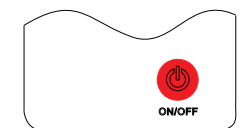

Press switch button LED Light flashes 2 times

Lamp switch off in daylight, will always keep weak brightness at night. PIR sensor will not work with this mode at night

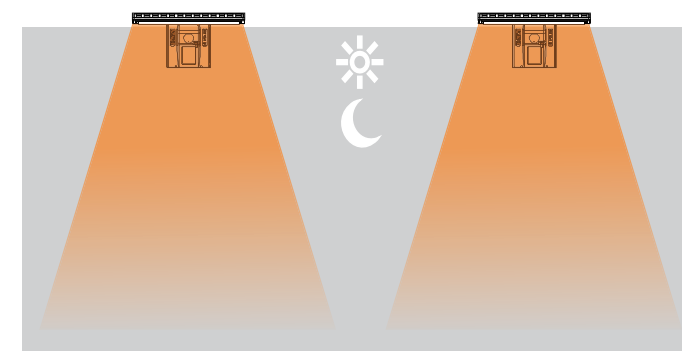

EMERGENCY MODE

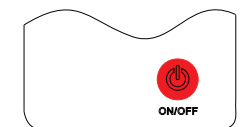

Press switch button for 5 seconds, lamp into emergency lighting, will keep full brightness all the time until battery is zero capacity. Press button 5 seconds again return normal mode.

UFO LED HIGHBAY LIGHT

LIGHT THE WORLD



Certification: CE,ROHS,TUV,FCC,SAA,C-tick



ITEM No.	MHB-U100-M	MHB-U150-M	MGB-U200-M
Led Power	100W	150W	200W
Lumen Output	14000lm	21000lm	28000lm
NW&GW(kg)	2.9 & 3.8	3.9 & 5.5	5.5 & 6.5
Product size(mm)	Dia250*H178	Dia299*H181	W345*H183
Carton size(mm)	320*320*165, 1pcs/CTN	355*350*165, 1pcs/CTN	410*410*175, 1pcs/CTN



Beam angle	60, 90, 120°	CRI	>80
Input Voltage	AC 85-305V	CCT	2700-6500k
Driver Brand	Meanwell driver	IP Grade	IP65
Led Lamp	SMD 3030	Power Factor	>0.95

UFO LED HIGHBAY LIGHT

LIGHT THE WORLD

Hook mounting

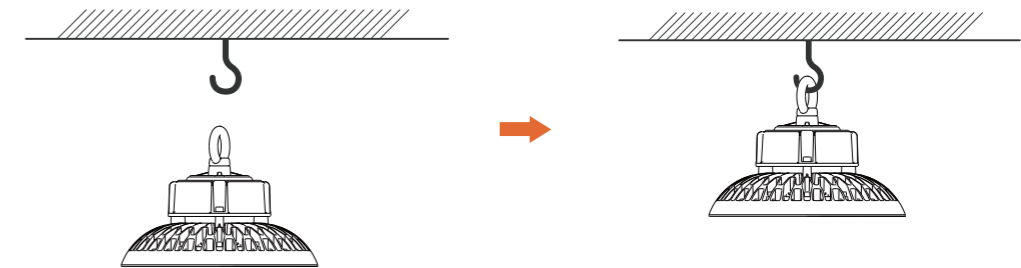

Structure

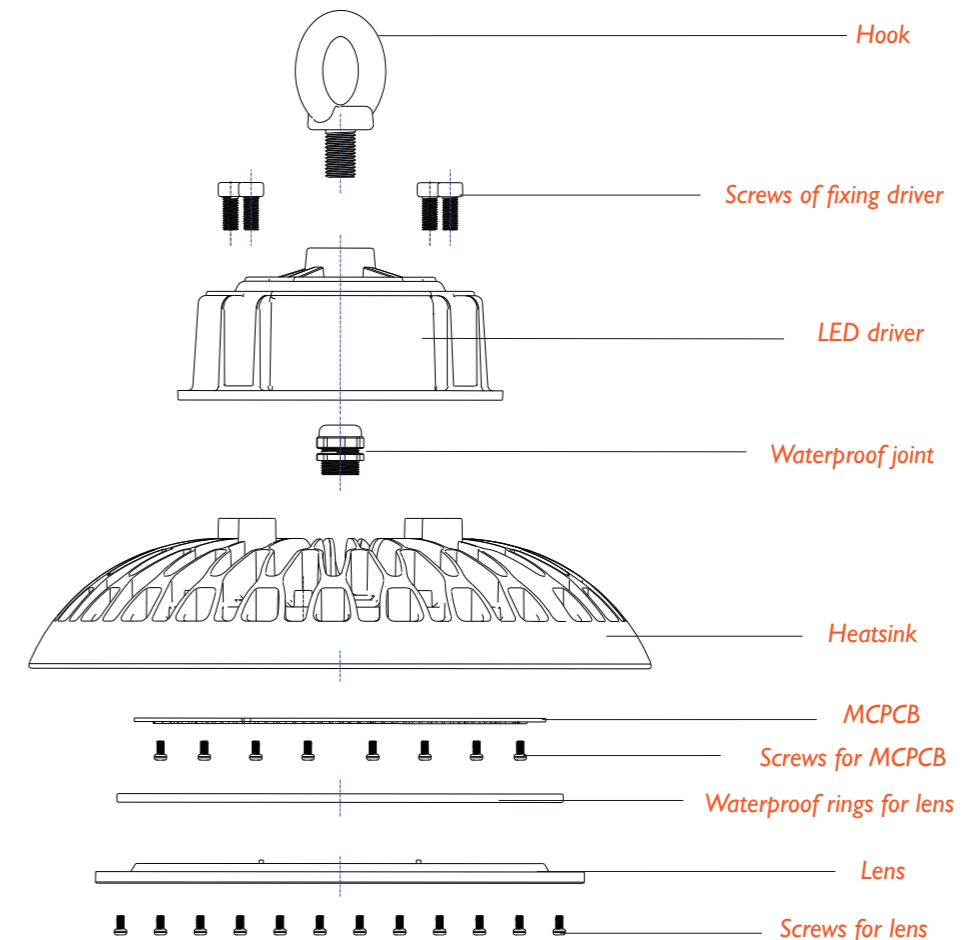

Product Introduction

MIC UFO high bay use high quality SMD 3030 LED CHIP and CE certificated LED Driver(AC85-300V) or Taiwan Meanwell UL Driver(AC185-528V). With unique Die-cast aluminum heat sink and optical lens different beam angle, the light is ideal product for warehouse area, workshop area, stadium area, shops and similar applications.

UFO LED HIGHBAY LIGHT

LIGHT THE WORLD

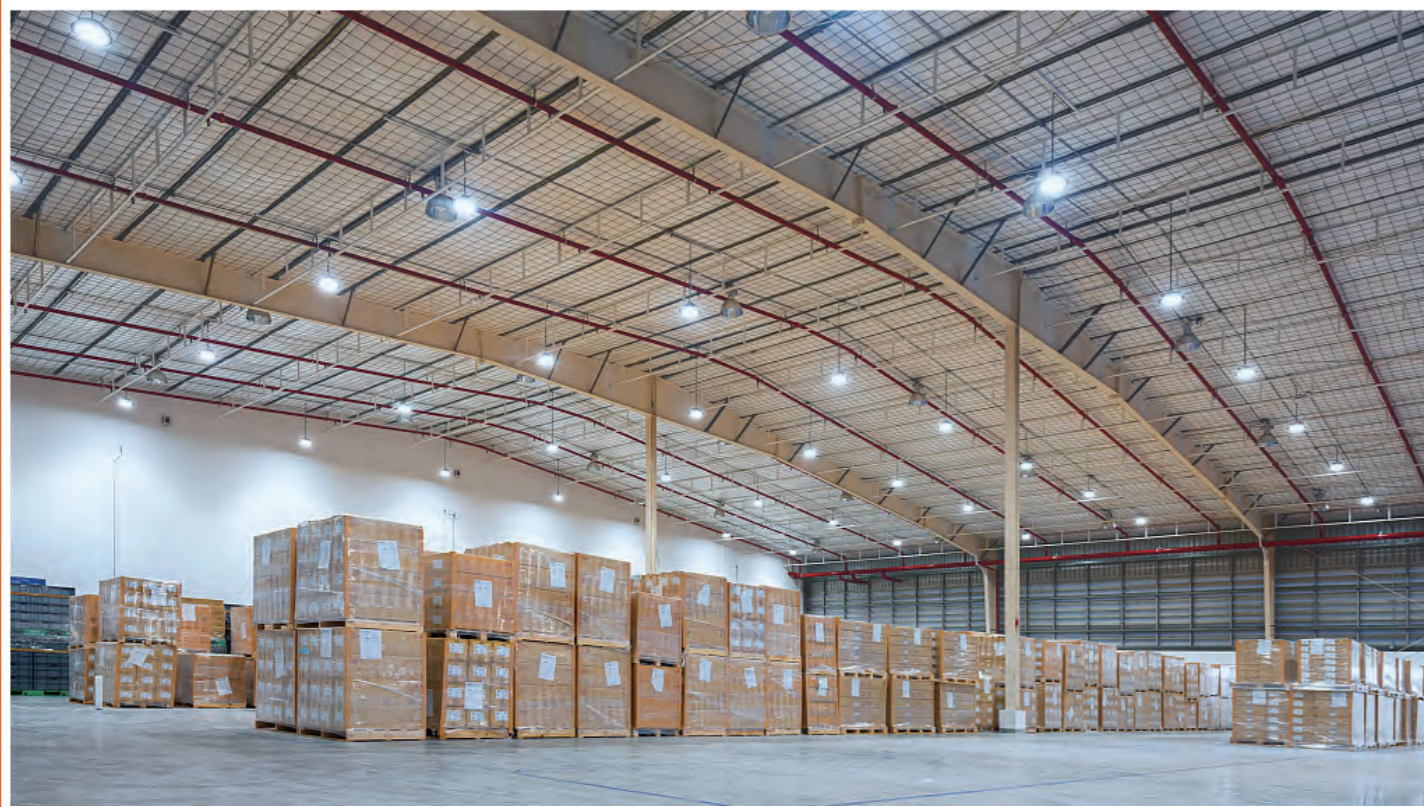

Certification: CE,ROHS,TUV,FCC,SAA,C-tick

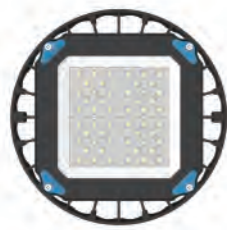

ITEM No.	MHB-U60-P	MHB-U100-P	MHB-U150-P	MHB-U200-P	MHB-U240-P
Led Power	60W	100W	150W	200W	240W
Lumen Output	9000lm	15000lm	22500lm	30000lm	36000lm
NW/GW(kg)	2.5 / 3.5	2.9 / 3.8	3.9 / 5.5	5.5 / 6.5	6.8 / 7
Product size(mm)	Dia215*97	Dia290*153	Dia362*153	Dia400*163	Dia400*163
Carton size(mm)	238*238*130mm	312*312*137mm	384*384*137mm	422*422*137mm	422*422*137mm



Light Efficient	> 150lm/w	CRI	>80
Input Voltage	AC 85-300V or 180-528V optional	CCT	2700-6500k
Driver Brand	Meanwell driver	IP Grade	IP66
Led Lamp	PHILIPS SMD 3030	Power Factor	>0.95

UFO LED HIGHBAY LIGHT

LIGHT THE WORLD

Hook mounting

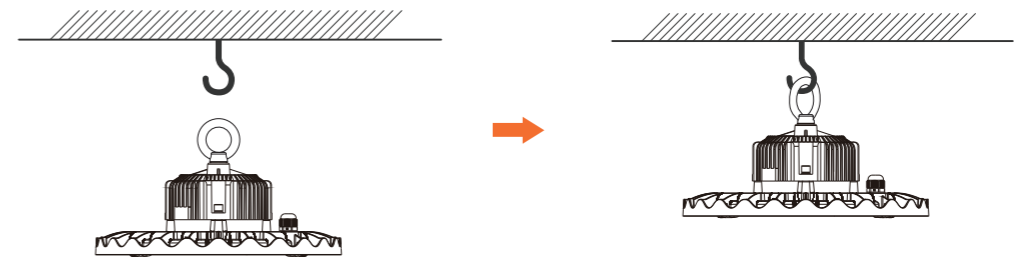

Beam angle

4 different beam angle for option

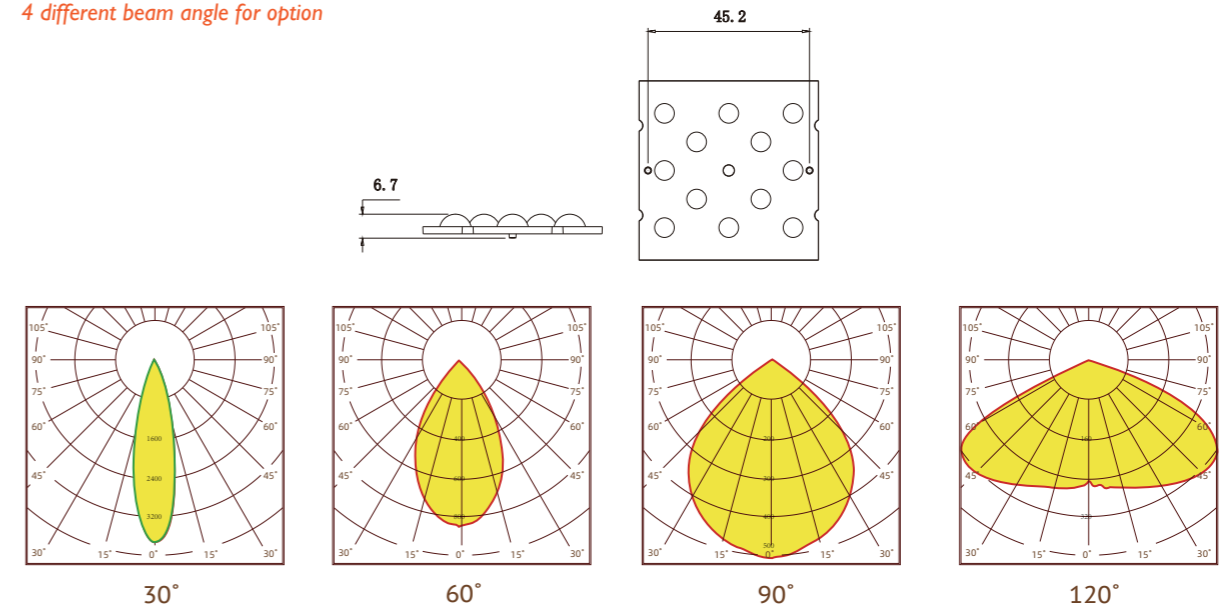

Structure

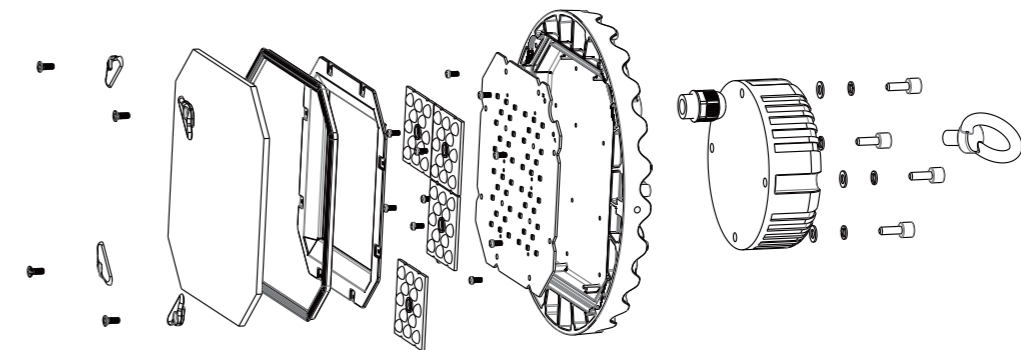

UFO LED HIGHBAY LIGHT

LIGHT THE WORLD

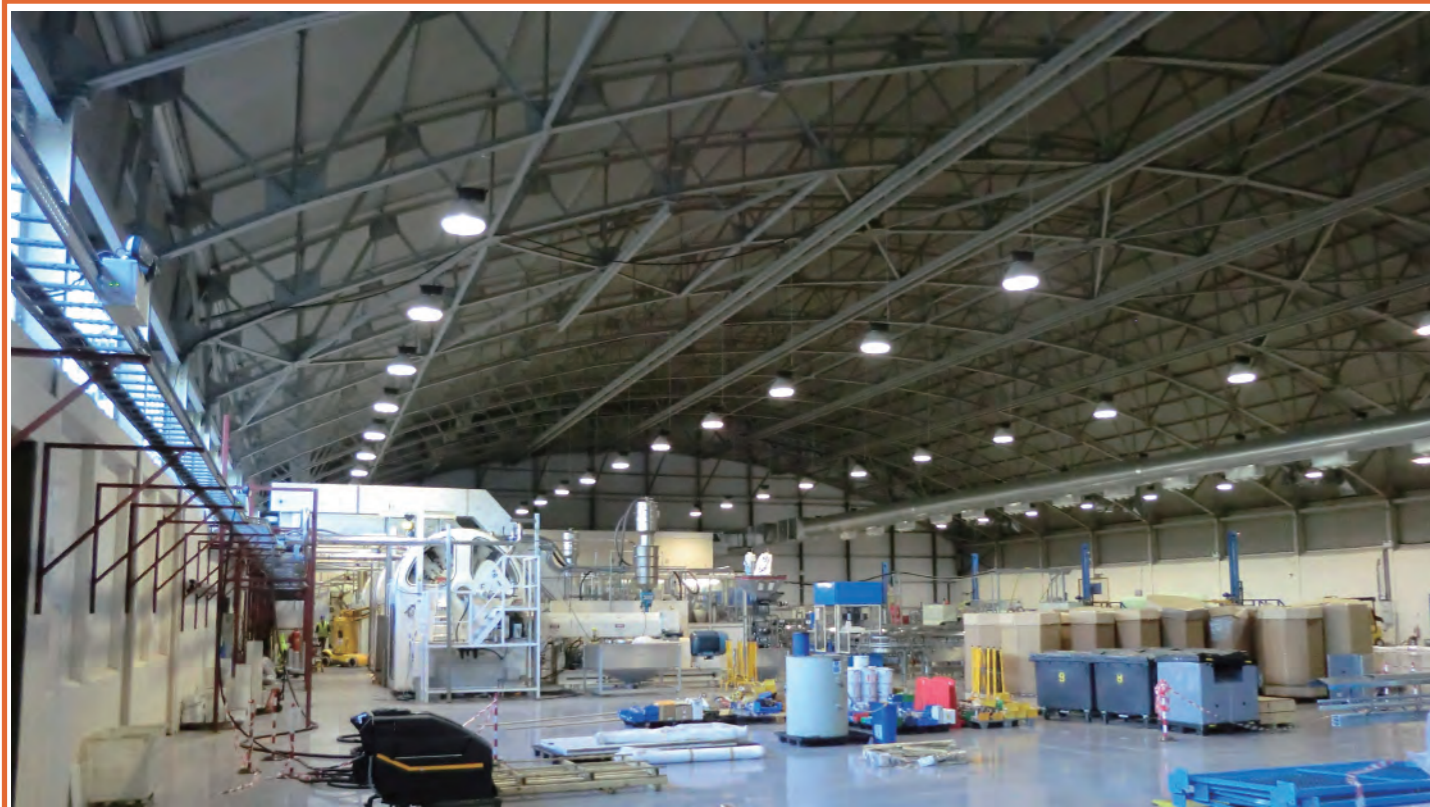

Certification: UL,CE,ROHS,TUV,FCC,SAA,C-tick



ITEM No.	MHB-U100-D	MHB-U150-D	MHB-U200-D	MHB-U240-D	MHB-U300-D
Led Power	100W	150W	200W	240W	300W
Lumen Output	13000lm	19500lm	26000lm	31200lm	39000lm
Weight	2.9kg	3.9kg	5.5kg	6kg	9.5kg
Product size(mm)	Dia280*150	Dia340*165	Dia400*180	Dia400*180	Dia440*180
Carton size(mm)	355*350*165, 1pcs/CTN	415*410*175, 1pcs/CTN	475*470*195, 1pcs/CTN	475*470*195, 1pcs/CTN	500*495*195, 1pcs/CTN



Beam angle	60°, 90°, 120°	CRI	>80
Input Voltage	AC 85-300V & 347V	CCT	2700-6500k
Driver Brand	CE/Meanwell UL driver	IP Grade	IP66
Led Lamp	PHILIPS SMD 3030 & 5050	Power Factor	>0.95

UFO LED HIGHBAY LIGHT

LIGHT THE WORLD

Adjustable bracket

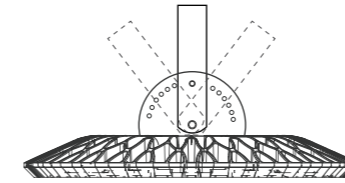

Structure

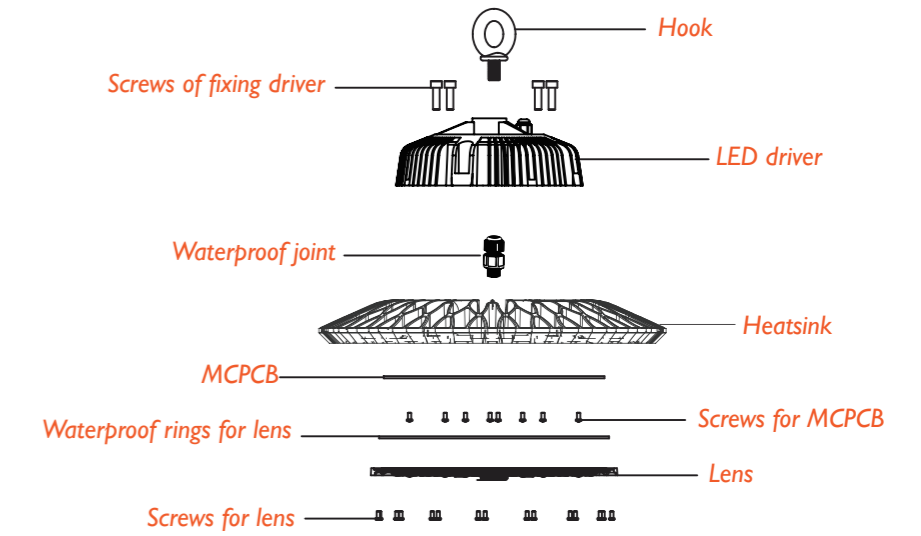

Hook mounting

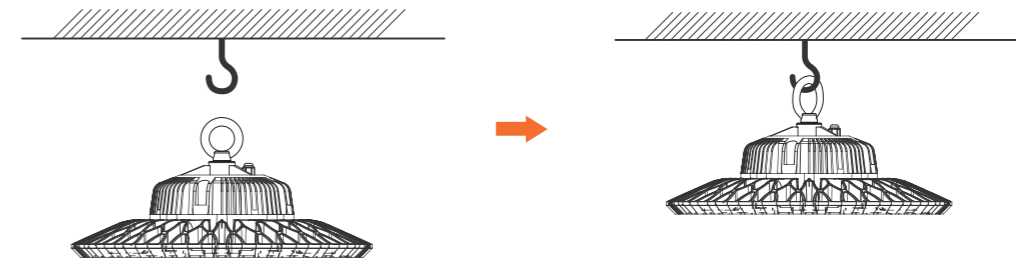

Bracket mounting



Product Introduction

MIC UFO high bay use high quality SMD3030 & 5050 LED CHIP and CE certificated LED Driver(AC85-300V) or Taiwan Meanwell UL Driver(AC85-300V/347V). With unique Die-cast aluminum heat sink and optical lens with different beam angle, the light is ideal for warehouse area, workshop area, stadium area, shops and similar applications.

UFO LED HIGHBAY LIGHT

LIGHT THE WORLD



Certification: UL,CE,ROHS,TUV,FCC,SAA,C-tick



ITEM No.	MHB-UI100-S	MHB-UI150-S	MHB-UI180-S
Led Power	100W	150W	180W
Lumen Output	15000lm	22500lm	28000lm
Weight	2.9kg	3.5kg	4.5kg
Product size(mm)	Dia280*155	Dia300*172	Dia320*192
Carton size(mm)	320*320*180, 1pcs/CTN	340*340*190, 1pcs/CTN	380*380*210, 1pcs/CTN



Beam angle	60°, 90°, 110°	CRI	>80
Input Voltage	AC 85-300V	CCT	2700-6500k
Driver Brand	CE/Meanwell UL driver	IP Grade	IP66
Led Lamp	OSRAM SMD 2835	Power Factor	>0.95

UFO LED HIGHBAY LIGHT

LIGHT THE WORLD

Installation

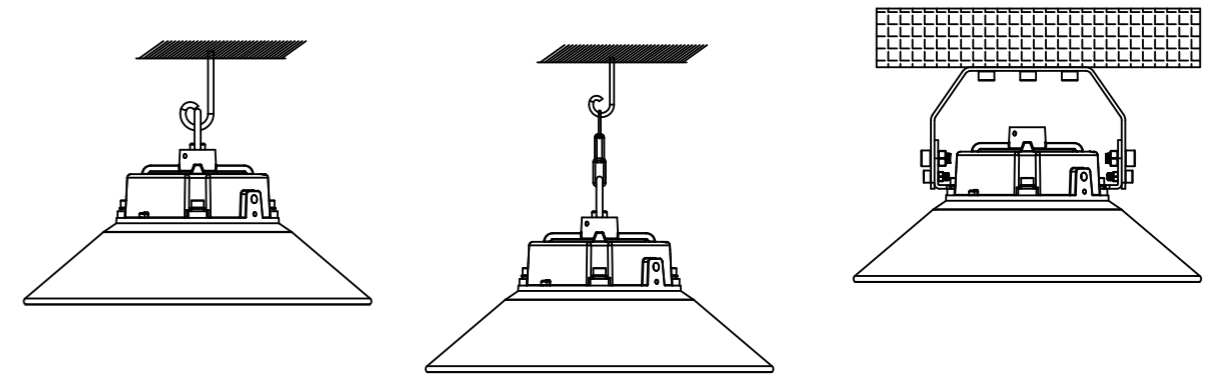

Installation instruction

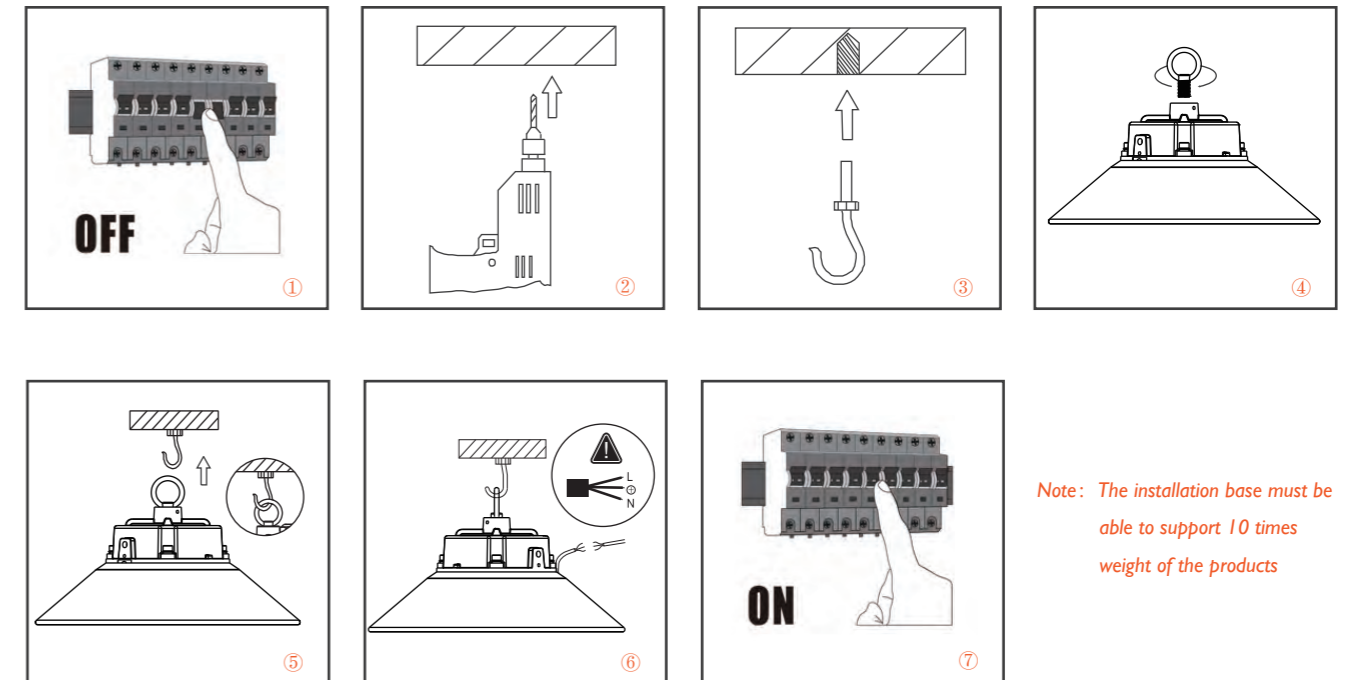

Note: The installation base must be able to support 10 times weight of the products

Warning

1. Please install the lamp according to the installation to avoid dropping and electric shock.
2. Don't exchange the lamp as will to avoid dropping ,electric shock and damage of the lamp.
3. Working voltage is not to be exceeded AC100-277V 50/60Hz

TRI-PROOF LED TUBE LIGHT

LIGHT THE WORLD



Certification: CE,ROHS,TUV,FCC,SAA,C-tick

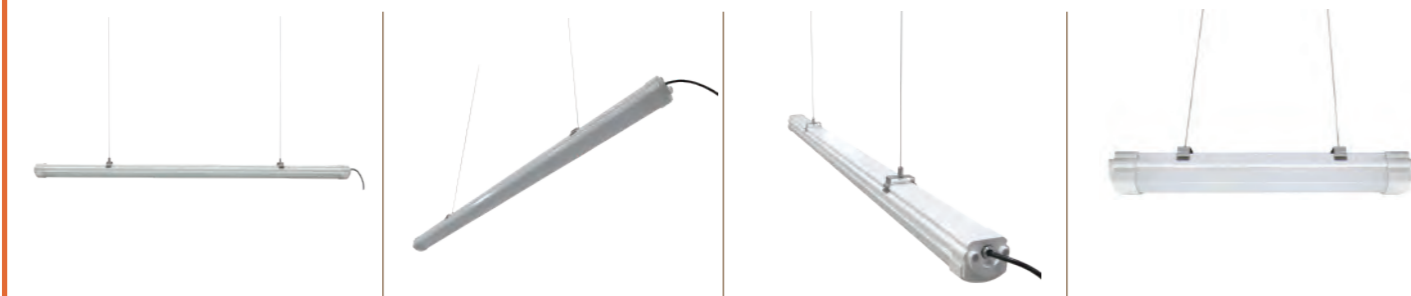

ITEM No.	MTP-T0620B	MTP-T0930B	MTP-T1240B	MTP-T1550B	MTP-T1860B
Led Power	20W	30W	40W	50W	60W
Lumen Output	2200lm	3300lm	4400lm	5500lm	6600lm
NW	0.8kg	0.9kg	1.1kg	1.4kg	1.6kg
Product size(mm)	63*58*630	63*58*930	63*58*1230	63*58*1530	63*58*1830
Carton size(mm)	660*290*160 8pcs/CTN	960*290*160 8pcs/CTN	1260*290*160 8pcs/CTN	1560*220*160 6pcs/CTN	1860*220*160 6pcs/CTN

Beam angle	120°	CRI	>80
Input Voltage	AC 100-277V / 200-240V	CCT	2700-6500k
Driver Brand	CE/Meanwell UL driver	IP Grade	IP65
Led Lamp	EPISTAR SMD 2835	Power Factor	>0.95

TRI-PROOF LED TUBE LIGHT

LIGHT THE WORLD

Special application for underground parking

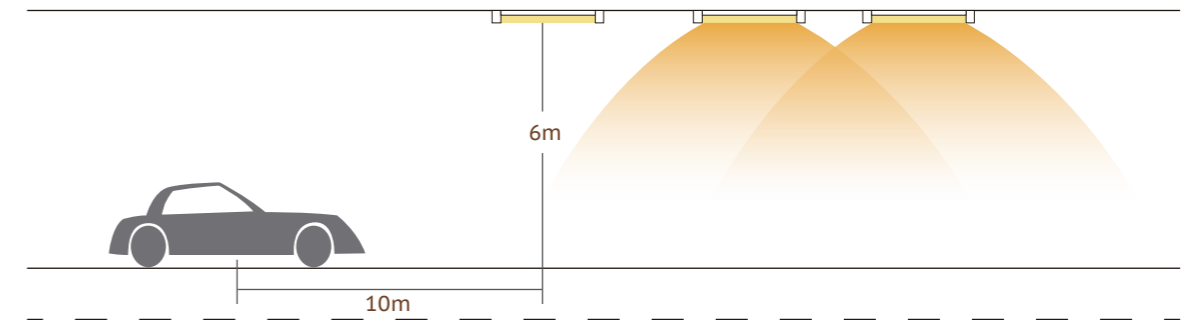

For general parking, the lamps will light up when the car get close to them, this will make the driver unable to adapt to the light shifting sharply and make the driver uncomfortable. Focus on the LED, we can provide the a perfect solution for such a defect, our lamps will light up automatically when the car is 10 meters away from the lamps.

Detection radius up to 8m, diameter up to 16m

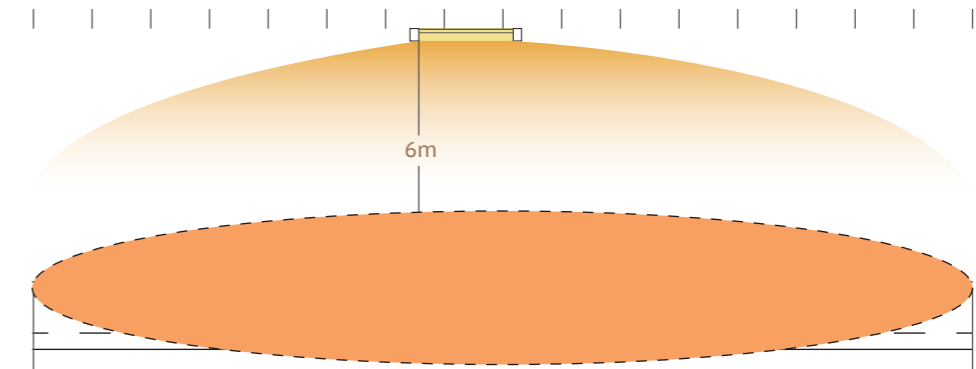

1. The installation distance between the two lamps should be more than 4 meters.
2. The product cannot be used in a small confined space, and adjustment according to actual. Use space induction distance geat, and the sensing direction there in no metal, glass objects such as blocking.

Widely used

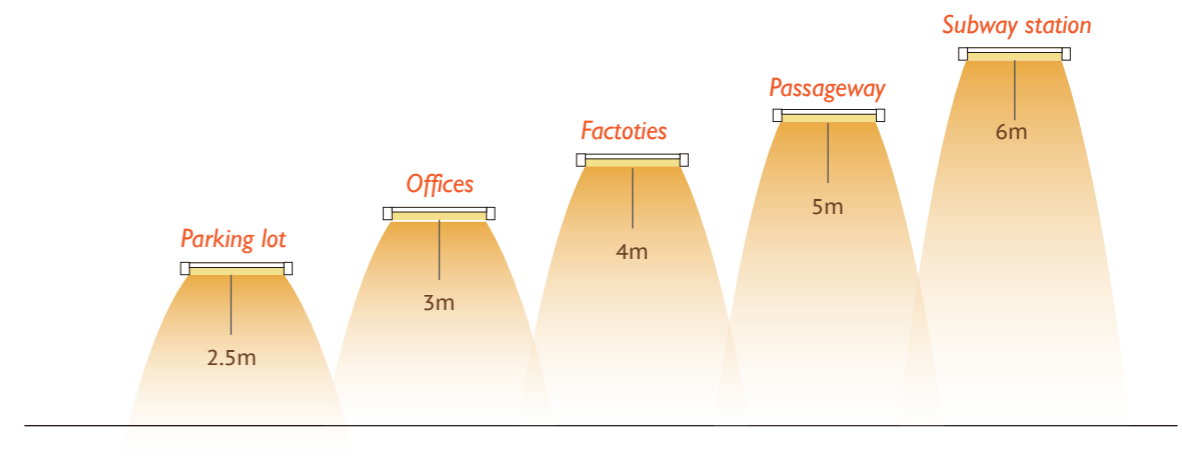

LED LINEAR HIGH BAY LIGHT

LIGHT THE WORLD



Certification: CE,ROHS,TUV,FCC,SAA,C-tick



ITEM No.	MLL-50	MLL-100	MLL-150	MLL-200
Led Power	50W	100W	150W	200W
Lumen Output	6000lm	12000lm	18000lm	24000lm
NW/GW	2.5kg/3kg	3.5kg/4kg	5kg/5.5kg	6.2kg/7.5kg
Product size(mm)	278*135*90	529*135*90	780*135*90	1131*135*90
Carton size(mm)	330*500*380, 4pcs/CTN	580*500*380, 4pcs/CTN	830*500*380, 4pcs/CTN	1180*500*380, 4pcs/CTN



Beam angle	30°,60°,90°,60°x90°,30°x70°,80°x155°	CRI	>80
Input Voltage	AC 100-277V	CCT	2700-6500k
Driver Brand	CE/Meanwell UL driver	IP Grade	IP65
Led Lamp	PHILIPS SMD 3030	Power Factor	>0.95

LED LINEAR HIGH BAY LIGHT

LIGHT THE WORLD

Spectrum

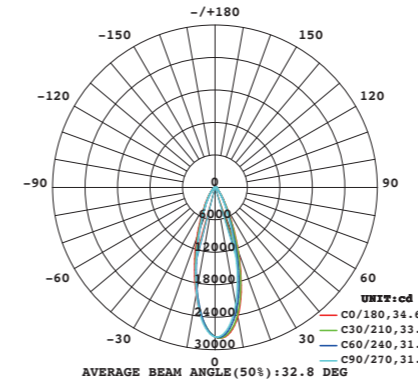

30deg

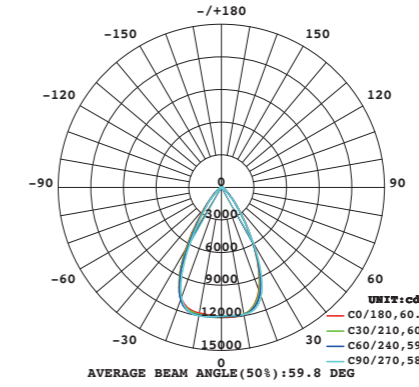

60deg

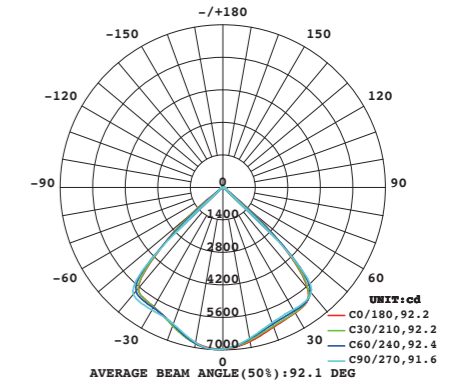

90deg

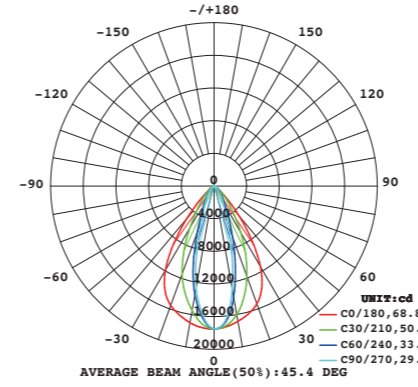

30*70deg

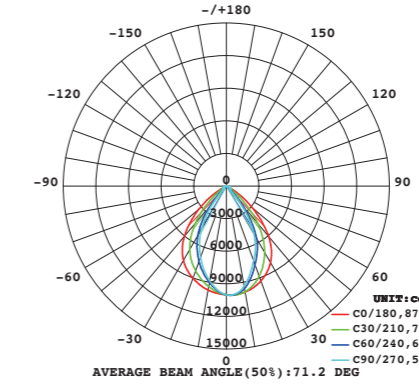

60*90deg

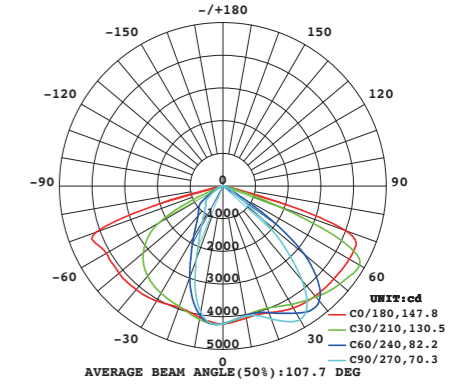

70*145deg

Installation

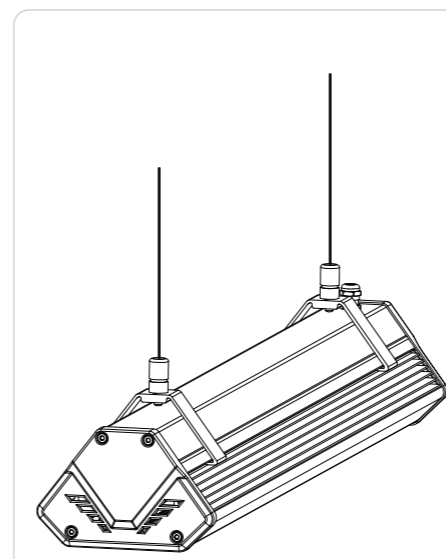

Suspension type

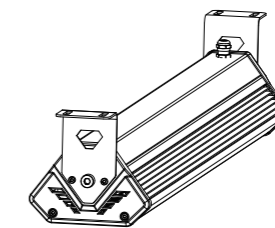

wall mounting type

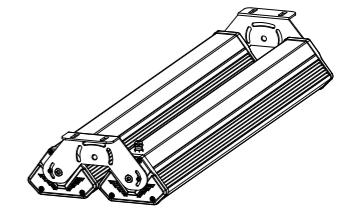

Two-module wall mounting type

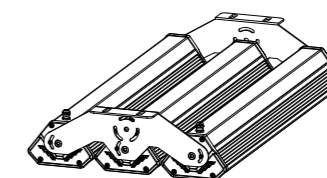

Three-module wall mounting type

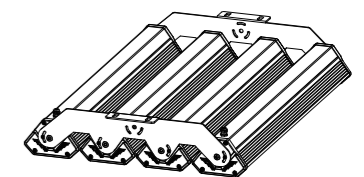

Four-module wall mounting type

LED CORN LIGHT

LIGHT THE WORLD



Certification: CE,ROHS,TUV,FCC,SAA,C-tick



ITEM No.	MYM-6	MYM-8	MYM-10	MYM-12
Led Power	6W	8W	10W	12W
Lumen Output	700lm	900lm	1100lm	1300lm
Weight	0.14kg	0.15kg	0.16kg	0.17kg
Product size(mm)	Dia48*L140	Dia48*L155	Dia48*L160	Dia48*L183
Carton size(mm)	560*560*400, 200pcs/CTN	560*560*400, 200pcs/CTN	560*560*400, 200pcs/CTN	560*560*400, 200pcs/CTN



Beam angle	360°	CRI	>80
Input Voltage	AC 85-300V	CCT	2700-6500k
Driver Brand	CE/JUL driver	IP Grade	IP40
Led Lamp	SAMSUNG SMD 2835	Power Factor	>0.95

LED CORN LIGHT

LIGHT THE WORLD

The explosion figure

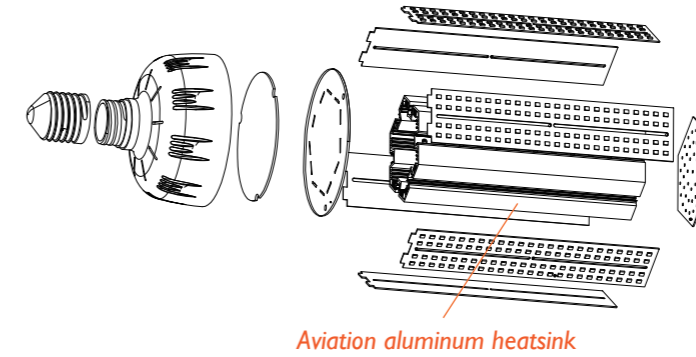

Pay attention

When the products are used for outdoor lighting, please take measures with adequate ventilation. Please pay attention to the size of the confined space. Let the lamp have enough space for heat dissipation for the lumen maintenance and extended-working life.

Installation and maintenance

1. Power must be cut off before installation. Be sure to remove the ballast before installation, it directly connect with wire AC85-300v.
2. If you want to replace the traditional fluorescent lights, please ensure you are using the correct socket which fits the lamp perfectly. Ensure that the input voltage and the lamp is matched. Make sure that the lamp base will hold three times the net weight of the lamp.
3. Make sure the products are installed tightly on the fixture, then plug in and turn on the light.
4. If phenomenon of smoke emitting and peculiar smell occurs, it may lead to electric shock or fire accident. Please cut off the power supply quickly and contact the maintenance personnel. Please do not disassemble it by yourself to avoid the electric shock accident.
5. Please do not replace the parts at random in case of to avoid accidents of lamp damage, falling down, electric shock and catching fire etc.
6. Please use dry cloth to clean it. Please do not use volatile matters such as paint thinner and gas to clean the surface of the lamps. Please do not spray pesticides onto the lights. Otherwise, it may lead to discoloration or damage of the lights.

LED WATERPROOF CORN LIGHT

LIGHT THE WORLD



Certification: CE,ROHS,TUV,FCC,SAA,C-tick



ITEM No.	MYM-25-02	MYM-30-02	MYM-35-02
Led Power	25W	30W	35W
Lumen Output	2870lm	3450lm	4025lm
Weight	0.63kg	0.71kg	0.78kg
Product size(mm)	Dia93*L209	Dia93*L240	Dia93*L240
Carton size(mm)	470*470*370, 21pcs/CTN	470*470*370, 21pcs/CTN	420*420*290, 16pcs/CTN

ITEM No.	MYM-40-02	MYM-50-02	MYM-60-02
Led Power	40W	50W	60W
Lumen Output	4600lm	5750lm	6900lm
Weight	0.85kg	0.85kg	0.85kg
Product size(mm)	Dia93*L270	Dia93*L280	Dia93*L280
Carton size(mm)	420*420*340, 16pcs/CTN	420*420*340, 16pcs/CTN	420*420*340, 16pcs/CTN

LED WATERPROOF CORN LIGHT

LIGHT THE WORLD



Beam angle	360°	CRI	>80
Input Voltage	AC 85-265V	CCT	2700-6500k
Driver Brand	CE/UL driver	IP Grade	IP65
Led Lamp	SAMSUNG SMD 5630	Power Factor	>0.95

The explosion figure

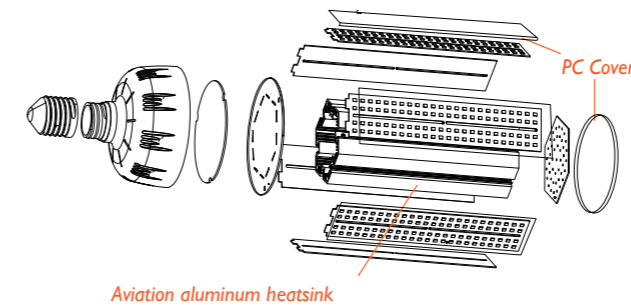

Pay attention

When the products are used for outdoor lighting, please take measures with adequate ventilation. Please pay attention to the size of the confined space. Let the lamp have enough space for heat dissipation for the lumen maintenance and extended working life.

Product features

1. Unique structure design, disconnect-type design of power supply and light source, easier for power supply and light source changing if needed.
2. Using diecasting aluminum heat sinking and active air exchanging cooling system which speed up heat spreading.
3. Widely used, no need of ballast, easy installation. Complies with the standards of TUV and ETL well.
4. Not applicable for dimmers, electronic switches and remote controls.
5. If used in sealed lamp fixtures it will reduce the lumen flux and working life. So we don't suggest to use it in the sealed fixture, especially for high power light of more than 60w. if over 80w, don't install in a sealed fixtures.
6. Mainly used in work places, supermarkets, garden for public places lighting.

Installation and maintenance

1. Power must be cut off before installation. Be sure to remove the ballast before installation, it directly connect with wire AC85-300v.
2. If you want to replace the traditional fluorescent lights, please ensure you are using the correct socket which fits the lamp perfectly. Ensure that the input voltage and the lamp is matched. Make sure that the lamp base will hold three times the net weight of the lamp.
3. Make sure the products are installed tightly on the fixture, then plug in and turn on the light.
4. If phenomenon of smoke emitting and peculiar smell occurs, it may lead to electric shock or fire accident. Please cut off the power supply quickly and contact the maintenance personnel. Please do not disassemble it by yourself to avoid the electric shock accident.
5. Please do not replace the parts at random in case of to avoid accidents of lamp damage, falling down, electric shock and catching fire etc.
6. Please use dry cloth to clean it. Please do not use volatile matters such as paint thinner and gas to clean the surface of the lamps. Please do not spray pesticides onto the lights. Otherwise, it may lead to discoloration or damage of the lights.

LED CORN LIGHT

LIGHT THE WORLD



Certification: CE,ROHS,TUV,FCC,SAA,C-tick



ITEM No.	MYM-30-03	MYM-50-03	MYM-60-03	MYM-80-03
Led Power	30W	50W	60W	80W
Lumen Output	3900lm	6500lm	7800lm	10400lm
Weight	0.44kg	0.53kg	0.57kg	0.8kg
Product size(mm)	Dia94*L167	Dia94*L196	Dia94*L228	Dia118*L255
Carton size(mm)	440*430*440, 18pcs/CTN	500*430*440, 18pcs/CTN	580*430*440, 18pcs/CTN	580*430*440, 18pcs/CTN

ITEM No.	MYM-100-03	MYM-120-03	MYM-150	MYM-200	MYM-250
Led Power	100W	120W	150W	200W	250W
Lumen Output	13000lm	15600lm	19500lm	26000lm	32500lm
Weight	0.86kg	0.9kg	1.83kg	1.9kg	2kg
Product size(mm)	Dia118*L308	Dia118*L336	Dia128*L315	Dia128*L335	Dia128*L365
Carton size(mm)	700*430*440, 18pcs/CTN	750*430*440, 18pcs/CTN	620*470*370, 12pcs/CTN	620*470*380, 12pcs/CTN	620*470*410, 12pcs/CTN

LED CORN LIGHT

LIGHT THE WORLD



Beam angle	360°	CRI	>80
Input Voltage	AC 85-300V	CCT	2700-6500k
Driver Brand	CE/JUL driver	IP Grade	IP40
Led Lamp	SAMSUNG SMD 2835	Power Factor	>0.95

The explosion figure

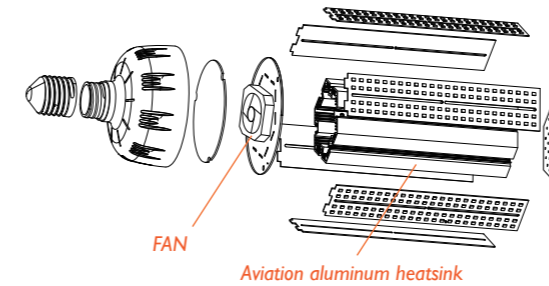

Pay attention

When the products are used for outdoor lighting, please take measures with adequate ventilation. Please pay attention to the size of the confined space. Let the lamp have enough space for heat dissipation for the lumen maintenance and extended working life.

Product features

1. Unique structure design, disconnect-type design of power supply and light source, easier for power supply and light source changing if needed.
2. Using aluminum+fan heat sinking and active air exchanging cooling system which speed up heat spreading.
3. Widely used, no need of ballast, easy installation. Complies with the standards of TUV and ETL well.
4. Not applicable for dimmers, electronic switches and remote controls.
5. If used in sealed lamp fixtures it will reduce the lumen flux and working life. So we don't suggest to use it in the sealed fixture, especially for high power light of more than 60w. if over 80w, don't install in a sealed fixtures.
6. Mainly used in work places, supermarkets, garden for public places lighting.

Installation and maintenance

1. Power must be cut off before installation. Be sure to remove the ballast before installation, it directly connect with wire AC85-300v.
2. If you want to replace the traditional fluorescent lights, please ensure you are using the correct socket which fits the lamp perfectly. Ensure that the input voltage and the lamp is matched. Make sure that the lamp base will hold three times the net weight of the lamp.
3. Make sure the products are installed tightly on the fixture, then plug in and turn on the light.
4. If phenomenon of smoke emitting and peculiar smell occurs, it may lead to electric shock or fire accident. Please cut off the power supply quickly and contact the maintenance personnel. Please do not disassemble it by yourself to avoid the electric shock accident.
5. Please do not replace the parts at random in case of to avoid accidents of lamp damage, falling down, electric shock and catching fire etc.
6. Please use dry cloth to clean it. Please do not use volatile matters such as paint thinner and gas to clean the surface of the lamps. Please do not spray pesticides onto the lights. Otherwise, it may lead to discoloration or damage of the lights.

LED CORN LIGHT

LIGHT THE WORLD

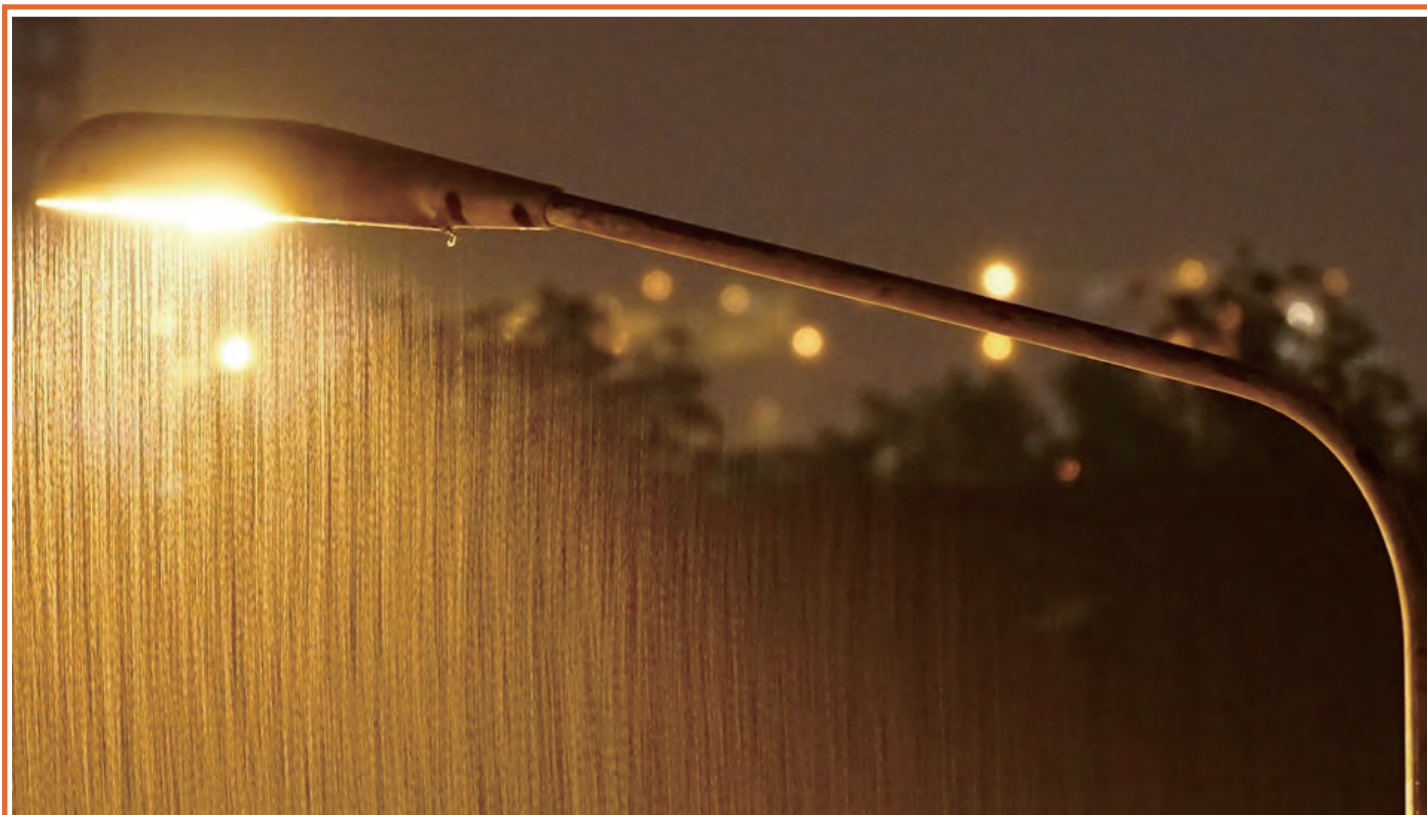

Certification: CE,ROHS,TUV,FCC,SAA,C-tick



ITEM No.	MYM-3M	MYM-5M	MYM-6M
Led Power	35W	45W	54W
Lumen Output	5250lm	6750lm	8100lm
Weight	0.7kg		
Product size(mm)	Dia98*L244		
Carton size(mm)	315*98*98, 1pc/box, 0.98kg; 420*420*340, 16pcs/ctn, 15.7kg		



Beam angle	360°	CRI	>80
Input Voltage	AC 85-300V	CCT	2700-6500k
Driver Brand	CE/UL driver	IP Grade	IP40
Led Lamp	SAMSUNG SMD 2835	Power Factor	>0.95

LED CORN LIGHT

LIGHT THE WORLD

Base Rotatable(180°) & Pay attention

When the products are used for outdoor lighting, please take measures with adequate ventilation. Please pay attention to the size of the confined space. Let the lamp have enough space for heat dissipation for the lumen maintenance and extended working life.

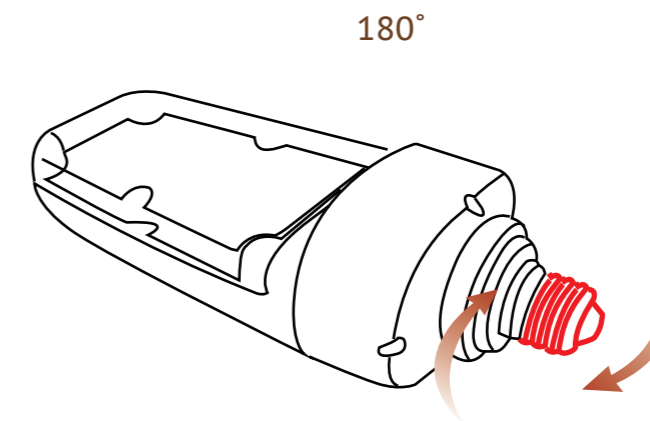

Product features

1. Unique structure design, disconnect-type design of power supply and light source, easier for power supply and light source changing if needed.
2. Using aluminum+fan heat sinking and active air exchanging cooling system which speed up heat spreading.
3. Widely used, no need of ballast, easy installation. Complies with the standards of TUV and ETL well.
4. Not applicable for dimmers, electronic switches and remote controls.
5. If used in sealed lamp fixtures it will reduce the lumen flux and working life. So we don't suggest to use it in the sealed fixture, especially for high power light of more than 60w. if over 80w, don't install in a sealed fixtures.
6. Mainly used in work places, supermarkets, garden for public places lighting.

Installation and maintenance

1. Power must be cut off before installation. Be sure to remove the ballast before installation, it directly connect with wire AC85-300v.
2. If you want to replace the traditional fluorescent lights, please ensure you are using the correct socket which fits the lamp perfectly. Ensure that the input voltage and the lamp is matched. Make sure that the lamp base will hold three times the net weight of the lamp.
3. Make sure the products are installed tightly on the fixture, then plug in and turn on the light.
4. If phenomenon of smoke emitting and peculiar smell occurs, it may lead to electric shock or fire accident. Please cut off the power supply quickly and contact the maintenance personnel. Please do not disassemble it by yourself to avoid the electric shock accident.
5. Please do not replace the parts at random in case of to avoid accidents of lamp damage, falling down, electric shock and catching fire etc.
6. Please use dry cloth to clean it. Please do not use volatile matters such as paint thinner and gas to clean the surface of the lamps. Please do not spray pesticides onto the lights. Otherwise, it may lead to discoloration or damage of the lights.

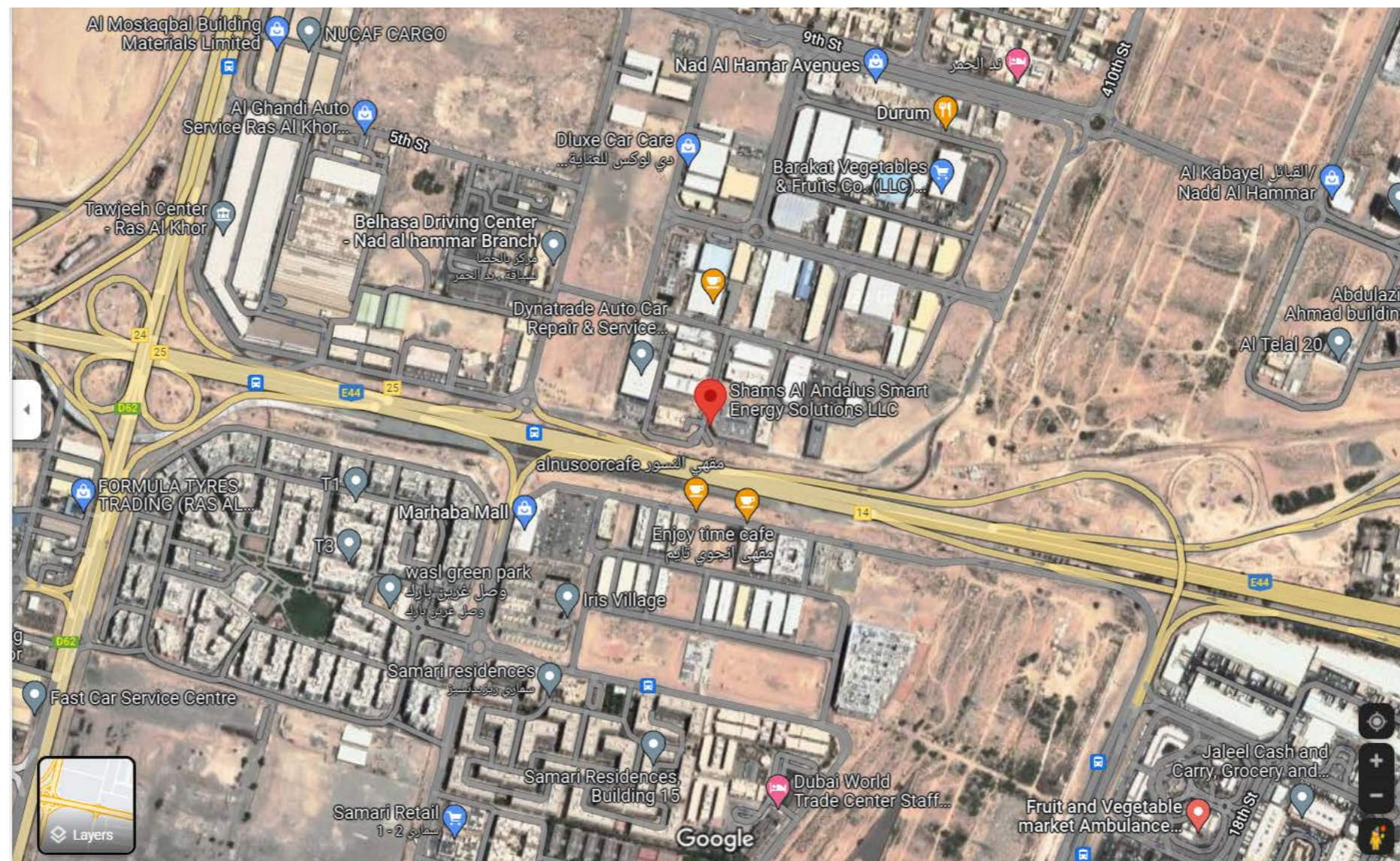

Phone: 0528458531

Email: info@alandalusmart.com

Website: www.alandalusmart.com

Dubai P.O.BOX 430555

Office Location: Dubai, Nad Al Hamar, Belresheed Building

Warehouse Location: Dubai, Al Qouz Industrial Area 2, 75 24B St.